

Panasonic®

Operating Instructions

BD/DVD Player

Model No. **DMP-BD10A**

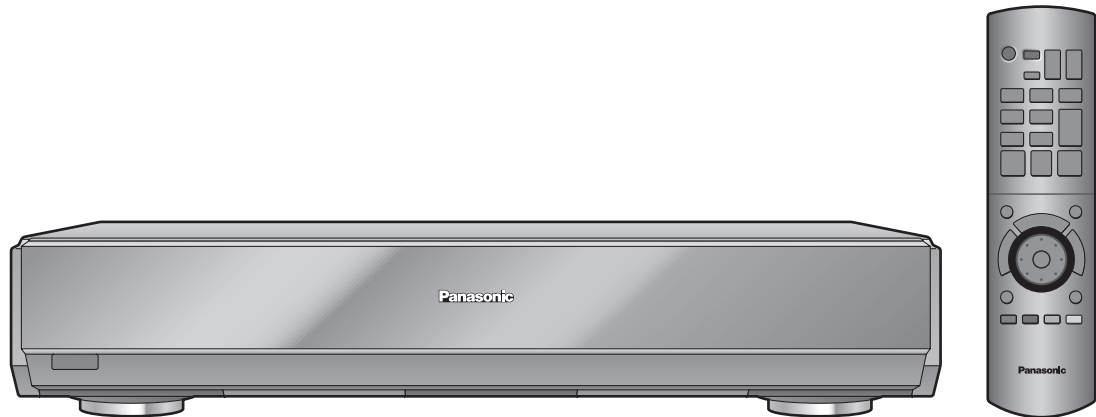

Dear customer

Thank you for purchasing this product.
For optimum performance and safety, please read these instructions carefully.

Before connecting, operating or adjusting this product, please read the instructions completely. Please keep this manual for future reference.



BD-Video



HDMI™
HIGH-DEFINITION MULTIMEDIA INTERFACE



AVCHD™

Region management information

BD-Video

This unit plays BD-Video marked with labels containing the region code A.

Region A

DVD-Video

This unit plays DVD-Video marked with labels containing the region number "1" or "ALL".

Example:



If you have any questions contact

U.S.A.: 1-800-211-PANA(7262)

Canada: 1-800-561-5505

U.S.A.: The warranty can be found on page 30.

Canada: The warranty can be found on page 31.

La referencia rápida en español se puede encontrar en la página 32.

IMPORTANT SAFETY INSTRUCTIONS

Read these operating instructions carefully before using the unit. Follow the safety instructions on the unit and the applicable safety instructions listed below. Keep these operating instructions handy for future reference.

- 1) Read these instructions.
- 2) Keep these instructions.
- 3) Heed all warnings.
- 4) Follow all instructions.
- 5) Do not use this apparatus near water.
- 6) Clean only with dry cloth.
- 7) Do not block any ventilation openings. Install in accordance with the manufacturer's instructions.
- 8) Do not install near any heat sources such as radiators, heat registers, stoves, or other apparatus (including amplifiers) that produce heat.
- 9) Do not defeat the safety purpose of the polarized or grounding-type plug. A polarized plug has two blades with one wider than the other. A grounding-type plug has two blades and a third grounding prong. The wide blade or the third prong are provided for your safety. If the provided plug does not fit into your outlet, consult an electrician for replacement of the obsolete outlet.
- 10) Protect the power cord from being walked on or pinched particularly at plugs, convenience receptacles, and the point where they exit from the apparatus.
- 11) Only use attachments/accessories specified by the manufacturer.
- 12) Use only with the cart, stand, tripod, bracket, or table specified by the manufacturer, or sold with the apparatus. When a cart is used, use caution when moving the cart/apparatus combination to avoid injury from tip-over.
- 13) Unplug this apparatus during lightning storms or when unused for long periods of time.
- 14) Refer all servicing to qualified service personnel. Servicing is required when the apparatus has been damaged in any way, such as power-supply cord or plug is damaged, liquid has been spilled or objects have fallen into the apparatus, the apparatus has been exposed to rain or moisture, does not operate normally, or has been dropped.



WARNING:

TO REDUCE THE RISK OF FIRE, ELECTRIC SHOCK OR PRODUCT DAMAGE,

- DO NOT EXPOSE THIS APPARATUS TO RAIN, MOISTURE, DRIPPING OR SPLASHING AND THAT NO OBJECTS FILLED WITH LIQUIDS, SUCH AS VASES, SHALL BE PLACED ON THE APPARATUS.
- USE ONLY THE RECOMMENDED ACCESSORIES.
- DO NOT REMOVE THE COVER (OR BACK); THERE ARE NO USER SERVICEABLE PARTS INSIDE. REFER SERVICING TO QUALIFIED SERVICE PERSONNEL.

CAUTION!

DO NOT INSTALL OR PLACE THIS UNIT IN A BOOKCASE, BUILT-IN CABINET OR IN ANOTHER CONFINED SPACE. ENSURE THE UNIT IS WELL VENTILATED. TO PREVENT RISK OF ELECTRIC SHOCK OR FIRE HAZARD DUE TO OVERHEATING, ENSURE THAT CURTAINS AND ANY OTHER MATERIALS DO NOT OBSTRUCT THE VENTILATION VENTS.

CAUTION!

THIS PRODUCT UTILIZES A LASER. USE OF CONTROLS OR ADJUSTMENTS OR PERFORMANCE OF PROCEDURES OTHER THAN THOSE SPECIFIED HEREIN MAY RESULT IN HAZARDOUS RADIATION EXPOSURE. DO NOT OPEN COVERS AND DO NOT REPAIR YOURSELF. REFER SERVICING TO QUALIFIED PERSONNEL.

CAUTION

Danger of explosion if battery is incorrectly replaced. Replace only with the same or equivalent type recommended by the manufacturer. Dispose of used batteries according to the manufacturer's instructions.

The socket outlet shall be installed near the equipment and easily accessible. The mains plug of the power supply cord shall remain readily operable.

To completely disconnect this apparatus from the AC Mains, disconnect the power supply cord plug from AC receptacle.

THE FOLLOWING APPLIES ONLY IN THE U.S.A.

FCC Note:

This equipment has been tested and found to comply with the limits for a Class B digital device, pursuant to Part 15 of the FCC Rules.

These limits are designed to provide reasonable protection against harmful interference in a residential installation. This equipment generates, uses and can radiate radio frequency energy and, if not installed and used in accordance with the instructions, may cause harmful interference to radio communications. However, there is no guarantee that interference will not occur in a particular installation. If this equipment does cause harmful interference to radio or television reception, which can be determined by turning the equipment off and on, the user is encouraged to try to correct the interference by one or more of the following measures:

- Reorient or relocate the receiving antenna.
- Increase the separation between the equipment and receiver.
- Connect the equipment into an outlet on a circuit different from that to which the receiver is connected.
- Consult the dealer or an experienced radio/TV technician for help.

Any unauthorized changes or modifications to this equipment would void the user's authority to operate this device.

This device complies with Part 15 of the FCC Rules. Operation is subject to the following two conditions: (1) This device may not cause harmful interference, and (2) this device must accept any interference received, including interference that may cause undesired operation.

Responsible Party:

Panasonic Corporation of North America
One Panasonic Way
Secaucus, NJ 07094

Support Contact:

Panasonic Consumer Electronics Company
Telephone No.: 1-800-211-7262

CAUTION

**RISK OF ELECTRIC SHOCK
DO NOT OPEN**

CAUTION: TO REDUCE THE RISK OF ELECTRIC SHOCK, DO NOT REMOVE SCREWS. NO USER-SERVICEABLE PARTS INSIDE. REFER SERVICING TO QUALIFIED SERVICE PERSONNEL.

The lightning flash with arrowhead symbol, within an equilateral triangle, is intended to alert the user to the presence of uninsulated "dangerous voltage" within the product's enclosure that may be of sufficient magnitude to constitute a risk of electric shock to persons.

The exclamation point within an equilateral triangle is intended to alert the user to the presence of important operating and maintenance (servicing) instructions in the literature accompanying the appliance.

CLASS 1 LASER PRODUCT KLASS 1 LASER APPARAT	LASER KLASSE 1 EN60825-1	LUOKAN 1 LASERLAITE APPAREIL À LASER DE CLASSE 1
<p>CAUTION – CLASS 2M LASER RADIATION WHEN OPEN. DO NOT STARE INTO THE BEAM OR VIEW DIRECTLY WITH OPTICAL INSTRUMENTS.</p> <p>VORSICHT – LASERSTRAHLUNG KLASSE 2M. WENN ABDECKUNG GEÖFFNET. NICHT IN DEN STRAHL BLICKEN ODER DIREKT MIT OPTISCHEN INSTRUMENTEN BETRACHTEN.</p> <p>ADVARSEL – KLASSE 2M LASERSTRÅLING VED ÅBNING. SE IKKE IND I STRÅLEN – HELLER IKKE MED OPTISKE INSTRUMENTER.</p> <p>ADVARSEL – KLASSE 2M LASERSTRÅLING NÅR DEKSEL ÅPNES. STIIRÅR IKKE INN I STRÅLEN ELLER SE DIREKTE MED OPTISKE INSTRUMENTER.</p> <p>VARNING – LASERSTRÅLNING KLASS 2M VID ÖPPEN LUCKA. STIRRA INTE IN I STRÅLEN VARKEN DIREKT ELLER GENOM OPTIK.</p> <p>VARO – AVATTAESSA OLET ALTTIINA LUOKAN 2M LASERSÄTELYLLE. ÄLÄ TÄMÖTÄ SÄTEESEEN TAI KATSO OPTISELLÄ LÄITTEELLÄ SUORAAN SÄTEESEEN.</p>		
<p>CAUTION – CLASS 3B INVISIBLE LASER RADIATION WHEN OPEN. AVOID EXPOSURE TO THE BEAM.</p> <p>VORSICHT – UNSICHTBARE LASERSTRAHLUNG KLASSE 3B. WENN ABDECKUNG GEÖFFNET. NICHT DEM STRAHL AUSSETZEN.</p> <p>ADVARSEL – KLASSE 3B USYNLIG LASERSTRÅLING VED ÅBNING. UNNGÅ UDSÆTTELSE FOR STRÅLING.</p> <p>ADVARSEL – KLASSE 3B USYNLIG LASERSTRÅLING NÅR DEKSEL ÅPNES. UNNGÅ EKSPONERING FOR STRÅLEN.</p> <p>VARNING – ÖSYNLIG LASERSTRÅLNING KLASS 3B VID ÖPPEN LUCKA. UNDVIK EXPONERING FÖR LASERSTRÅLNINGEN.</p> <p>VARO – AVATTAESSA OLET ALTTIINA LUOKAN 3B NÄKYMÄTÖNTÄ LASERSÄTELYÄ. VARO ALTISTUMISTA SÄTEELLE.</p>		
<p>CAUTION – Laser radiation when open. DO NOT STARE INTO BEAM.</p> <p>DANGER – Invisible Laser radiation when open. AVOID DIRECT EXPOSURE TO BEAM.</p>		

(Inside of product)

Table of contents

Getting started

IMPORTANT SAFETY INSTRUCTIONS.....	2
Accessory information	3
Disc information.....	4
Control reference guide.....	6
Connection	8
Easy Setting.....	11
Remote control setting.....	11

Playback

Basic play	12
Adjusting picture and sound quality.....	14
Operations using menu screen	15
Playing MP3 files and still pictures	16
Linked operations with the TV (EZ Sync™ “HDAVI Control™”)	18

Settings

Changing settings with the On-screen menu.....	19
Changing the unit's settings.....	21

Reference

Frequently asked questions.....	24
Troubleshooting guide	24
Messages	27
Disc handling.....	27
Maintenance	27
Product Service.....	28
Specifications.....	28
Glossary	29
Limited Warranty (ONLY FOR U.S.A.)	30
Limited Warranty (ONLY FOR CANADA)	31
<i>Referencia rápida en español</i> (Spanish Quick Reference)	32
Index.....	33

Accessory information



Please check and identify the supplied accessories. Use numbers indicated in parentheses when asking for replacement parts.
(Product numbers correct as of April 2007. These may be subject to change.)

Only for U.S.A.: To order accessories, refer to “Accessory Purchases” on page 30.

Only for Canada: To order accessories, call the dealer from whom you have made your purchase.



1 Remote control
(EUR7658YF0)



1 Audio/video cable
(K2KA6BA00003)



2 Batteries
for remote control

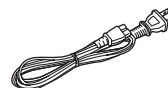

1 AC power supply cord
(K2CB2CB00018)

- For use with this unit only. Do not use it with other equipment. Also, do not use cords for other equipment with this unit.

The enclosed Canadian French label sheet corresponds to the English display on the front and back side of the unit.

(ONLY FOR U.S.A.)

Product Registration Card

Please complete and return the included product registration card, or register via the Internet at: <http://www.prodreg.com/panasonic/>

The model number and serial number of this product can be found on either the back or the bottom of the unit. Please note them in the space provided below and keep for future reference.

MODEL NUMBER _____ DMP-BD10A _____

SERIAL NUMBER _____

User memo:

DATE OF PURCHASE _____

DEALER NAME _____

DEALER ADDRESS _____











TELEPHONE NUMBER _____

Disc information

This unit is compatible with a variety of disc types and formats, including both packaged discs and recorded discs. Use the following chart to learn more about the discs that can be played on this unit.

Packaged discs

This chart shows the different type of retail/commercial discs you can use, and also includes the industry-standard logos that should appear on the discs and/or packaging.









	Logo	Features	Indicated as
	 BD-Video	High Definition (HD) movie and music discs	BD-V
	 DVD VIDEO	High quality movie and music discs.	DVD-V
	 DVD AUDIO	High fidelity music discs. Some DVD-Audio discs contain DVD-Video content.*.	DVD-A DVD-V
	 COMPACT DISC DIGITAL VIDEO	Compact Discs (CD's) that contain music and video. Including SVCD (Conforming to IEC62107)	VCD
	 COMPACT DISC DIGITAL AUDIO	Compact Discs (CD's) that contain audio and music.	CD

*To play DVD-Video content, set "Play DVD-Audio in Video Mode" to "Video Mode (Video On)" (► 21, "Disc" tab)

Recorded discs

This chart shows the different type of discs recorded with DVD recorders, DVD video cameras, personal computers, etc. that you can use.

Finalized This mark means you must finalize (► 29, Glossary) the disc with the DVD recorder, etc. before playback.

	Logo	Formats	Indicated as
	 DVD RAM 4.7	<ul style="list-style-type: none"> Discs recorded using Version 1.1 of the DVD Video Recording Format (a unified video recording standard). JPEG format AVCHD format 	DVD-VR JPEG BD-V
 Finalized	 DVD R 4.7 DVD RW	<ul style="list-style-type: none"> Discs recorded using DVD-Video Format. Discs recorded using Version 1.1 of the DVD Video Recording Format (a unified video recording standard). AVCHD format 	DVD-V DVD-VR BD-V
 Finalized	 DVD R DL	<ul style="list-style-type: none"> Discs recorded using DVD-Video Format. Discs recorded using Version 1.2 of the DVD Video Recording Format (a unified video recording standard). AVCHD format 	DVD-V DVD-VR BD-V
 Finalized	—	<ul style="list-style-type: none"> Discs recorded using +VR (+R/+RW Video Recording) format. 	DVD-V
 Finalized	—	<ul style="list-style-type: none"> CD-DA format VCD formats including SVCD (Conforming to IEC62107) MP3 format. JPEG format 	CD VCD MP3 JPEG

•It may not be possible to play the above discs in some cases due to the type of discs, the condition of the recording, the recording method and how the files were created.

Regarding BD-Video

- When BD-J application (► 29, Glossary) is executed, operations may take a little more time than usual. Please wait, there is nothing wrong with this unit.
- When playing a set of two BD-Video discs, once the first disc finishes playing, video may continue to display even if playback has been stopped.
- If the audio track of the disc was recorded with DTS-HD Master Audio, it will be output as DTS Digital Surround audio.
- When playing discs recorded with Dolby TrueHD or DTS-HD,
 - audio will not be output properly (e.g. audio from some speakers cannot be heard) unless the number of connected speakers is the same as audio channel specification of the disc.
 - even if you select “Small” in the speaker settings, audio output will have an effect similar to when “Large” is selected (► 23).

Regarding DVD-Audio

Some multi-channel DVD-Audio will prevent down-mixing (► 29, Glossary) of all or part of their contents if this is the manufacturer’s intention. When playing such discs, or such parts of the disc, unless the number of connected speakers is the same as audio channel specification of the disc, audio will not be output properly (e.g. part of the audio is missing, multi-channel audio cannot be selected and audio is played in two channels). Refer to the disc’s jacket for more information.

Note about using a DualDisc

The digital audio content side of a DualDisc does not meet the technical specifications of the Compact Disc Digital Audio (CD-DA) format so play may not be possible.

Tips for making MP3/JPEG files

File format	MP3	JPEG
Playable discs	CD-R/RW*1	DVD-RAM*2, CD-R/RW*1
Extension	Files must have the extension “.mp3” or “.MP3”.	Files must have the extension “.jpg” or “.JPG”.
Number of pixels	—	between 34×34 and 6144×4096 pixels (Sub sampling is 4:2:2 or 4:2:0)
Bit rates	32 kbps to 320 kbps	—
Sampling frequency	44.1 kHz/48 kHz	—
Reference	<ul style="list-style-type: none"> • ID3 tags: not compatible • If there is a large amount of still picture data etc. within a MP3 file, play may not be possible. 	<ul style="list-style-type: none"> • Compatible formats: DCF*3 compliant (Content recorded on a digital camera, etc.) • MOTION JPEG: not compatible
	<ul style="list-style-type: none"> • English alphabet and Arabic numerals are displayed correctly. Other characters may not be displayed correctly. • The display order on this unit may differ from how the order is displayed on a computer. • Depending on how you create the disc (writing software), files (tracks) and folders (groups) may not play in the order you numbered them. • This unit is not compatible with packet-write format. • Depending on the recording conditions, the disc may not play. • Operation may take time to complete when there are many files (tracks) and/or folders (groups) and some files (tracks) may not display or be playable. 	

*1 CD-R/RW

- Compatible formats: ISO9660 level 1 or 2 (except for extended formats), Joliet
- This unit is compatible with multi-session but reading or play of the disc may take time if there are a lot of sessions.

*2 DVD-RAM

- Discs must conform to UDF 2.0.

*3 Design rule for Camera File system: unified standard established by Japan Electronics and Information Technology Industries Association (JEITA).

You can play MP3 and still pictures (JPEG) on this unit by making folders as shown below. However depending on how you create the disc (writing software), play may not be in the order you numbered the folders.

Structure of MP3 folders in CD-R/CD-RW	Structures of still pictures (JPEG) in CD-R/CD-RW
<p>Prefix with 3-digit numbers in the order you want to play them.</p>	<p>Files inside a folder are displayed in the order they were updated or taken.</p> <ul style="list-style-type: none"> • When the highest level folders are “DCIM” folders, they are displayed first on the tree.

Discs that cannot be played

- BD-R, BD-RE v1/v2
- 2.6-GB and 5.2-GB DVD-RAM
- DVD-RAM that cannot be removed from their cartridges
- Version 1.0 of DVD-RW
- DVD-ROM, CD-ROM, CDV, CD-G, SACD and Photo CD
- WMA discs
- DivX discs
- PAL discs
- “Chaoji VCD” available on the market including CVD, DVCD and SVCD that do not conform to IEC62107.
- HD DVD
- Other discs that are not specifically supported

Control reference guide

Remote control

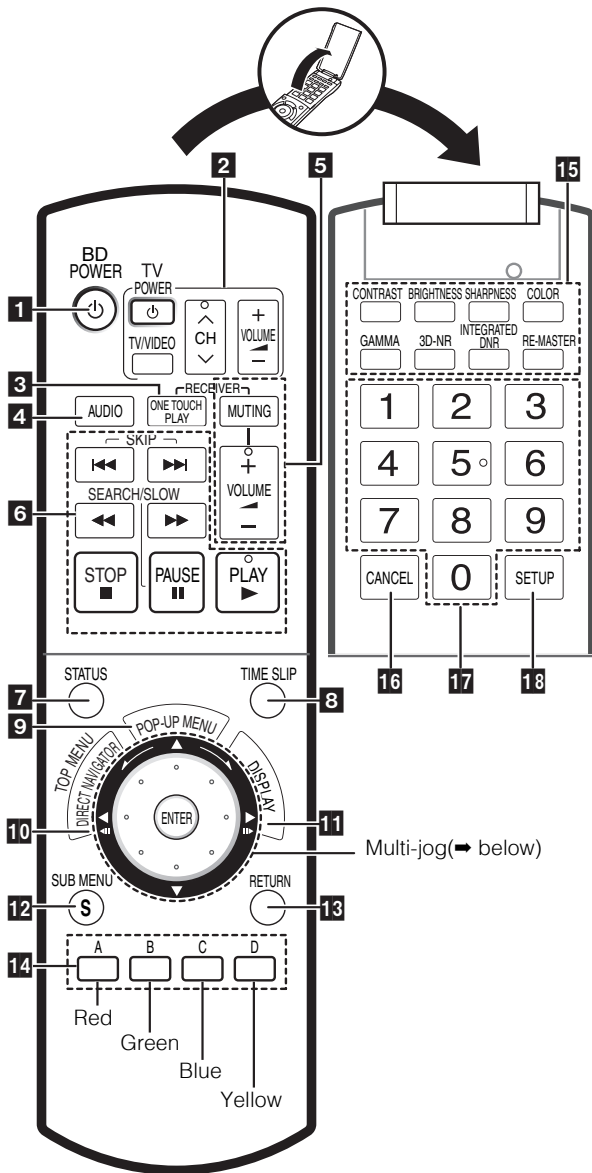

Multi-jog operation

- Select items on menu screens and set items.

[▲, ▼, ◀, ▶]

Press up, down, left or right to select an item.

You can also turn the wheel to select an item.

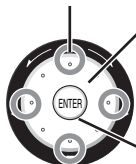

Press [ENTER] to confirm.

See page 13 for the operations during playback.



- Turn the Multi-jog lightly.

If you press it strongly when turning it, [▲, ▼, ◀, ▶] may be mistakenly activated.

- About Multi-jog Setting

The wheel operation can be turned off. Set the "Multi-jog Setting" to "Off" (▶ 21, "Setup" tab).

- 1** Turn the unit on and off (▶ 11)

- 2** **TV operation buttons**

You can operate the TV through the unit's remote control. See page 11 for the remote control setting.

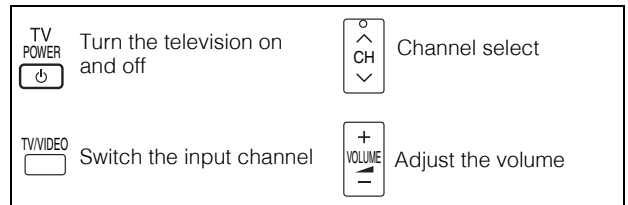

- 3** (▶ 18)

Works only with Panasonic EZ Sync "HDAVI Control" compatible equipment.

- 4** Select audio (▶ 13)

- 5** **Receiver operation buttons**

You can operate a Panasonic amplifier/receiver through the unit's remote control.

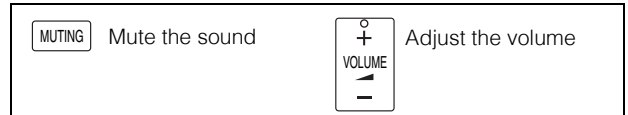

- 6** **Basic playback control buttons**

See page 12 for the details.

- 7** Show status messages (▶ 13)

- 8** Skip the specified time (▶ 13)

- 9** Show Pop-up menu (▶ 15)

- 10** Show Top menu/Direct Navigator (▶ 15)

- 11** Show On-screen menu (▶ 19)

- 12** Show sub menu (▶ 15, 17)

- 13** Return to previous screen

- 14**

These buttons are used when operating a BD-Video disc that includes Java™ applications (BD-J). For more information about operating this kind of disc, please read the instructions that came with the disc.

The A and B buttons are also used with the "Title View", "Picture View" and "Album View" screens.

- 15** **Buttons that adjust picture and sound quality**

See page 14 for the details.

- 16** Cancel

- 17** **Numbered buttons**

Select title numbers, etc./Enter numbers (▶ 13)

- 18** Show Setup menu (▶ 21)

Main unit

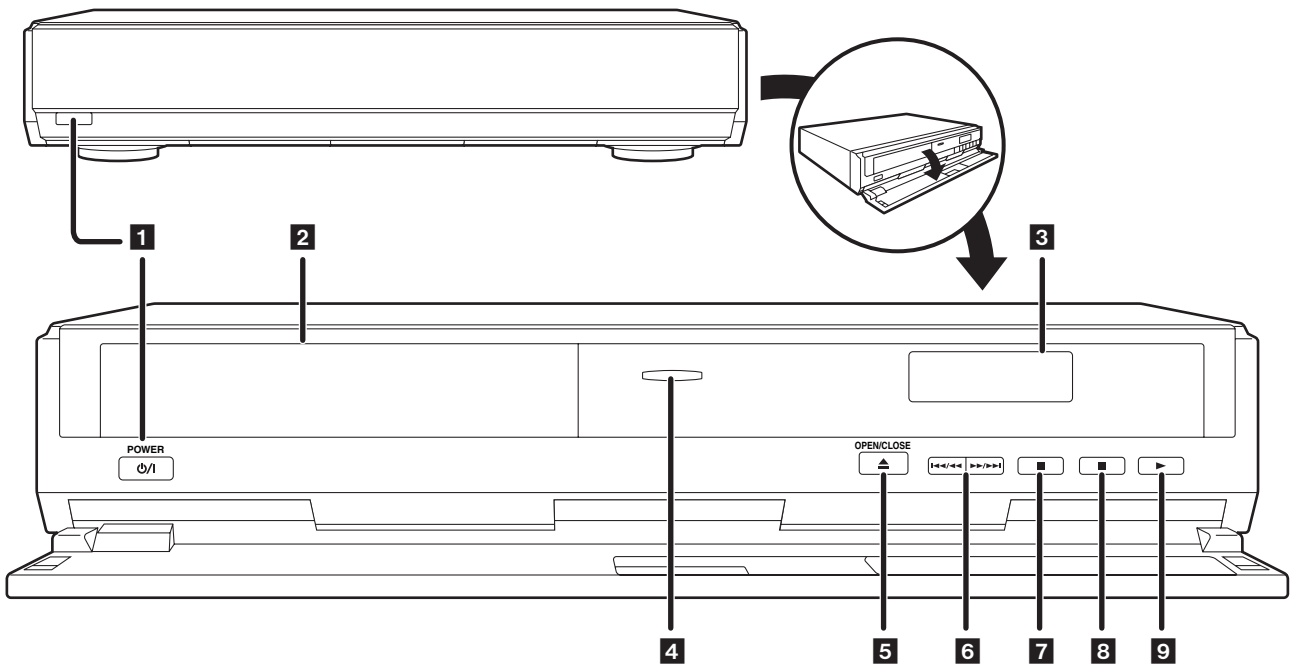

- 1** POWER
 POWER button (⏻/⏻ POWER) (→ 12)

Press to switch the unit from on to standby mode or vice versa. In standby mode, the unit is still consuming a small amount of power.

- 2** Disc tray (→ 12)

- 3** Display

- 4** Illumination lamp
 Lights when the unit is turned on.

- 5** OPEN/CLOSE
 Open/close disc tray (→ 12)

- 6**  Search / Skip
 Search: Press and hold
 Skip: Press

- 7**  Stop (→ 12)

- 8**  Pause (→ 12)

- 9**  Start play (→ 12)

Rear panel terminals (→ 8–10)

Using remote control

Batteries

Insert so the poles (+ and –) match those in the remote control. When closing the lid, insert it from the – (minus) side.

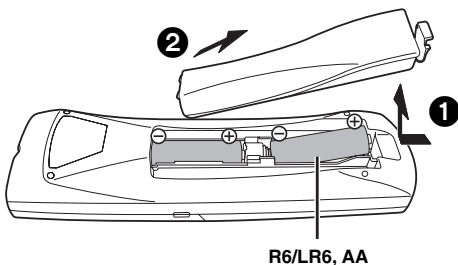

- Do not use rechargeable type batteries.
- Do not mix old and new batteries.
- Do not use different types at the same time.
- Do not heat or expose to flame.
- Do not take apart or short circuit.
- Do not attempt to recharge alkaline or manganese batteries.
- Do not use batteries if the covering has been peeled off.

Mishandling of batteries can cause electrolyte leakage which can damage items the fluid contacts and may cause a fire. Remove batteries if the remote control is not going to be used for a long period of time. Store in a cool, dark place.

Use

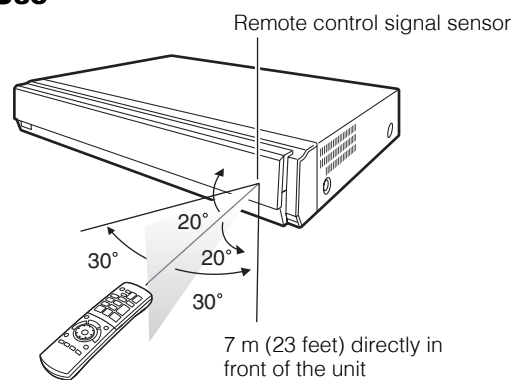

If you cannot operate the unit or television using the remote control after changing the batteries, please re-enter the codes (→ 11).

Connection

From the list below, please choose the connection method that fits your TV viewing environment best and follow the illustrations to connect your player.

- If you connect to a television using an included Audio/Video cable → **A**
- If you connect to an HDMI (⇒ 29, Glossary) compatible television → **B**
- If you connect to an HDMI compatible television and an HDMI compatible amplifier/receiver to enjoy surround sound → **C** (⇒ 9)

The connection examples (**A B C**) are the most commonly used methods for connecting the unit. For other connection methods, please see pages 9 and 10.

- Do not place the unit on amplifiers or equipment that may become hot. The heat can damage the unit.
- **Do not connect through the video cassette recorder.** Due to copy guard protection, the picture may not display properly.
- Turn off all equipment before connection and read the appropriate operating instructions.
- Connect terminals of the same color.

Conserving power

This unit consumes a small amount of power even when it is turned off (less than 1 W). To save power when the unit is not to be used for a long time, unplug it from the household AC outlet.

Please use HDMI cables that have the HDMI logo (as shown on the cover). It is recommended that you use Panasonic's HDMI cable.

Recommended part number: RP-CDHG15 (1.5 m/4.9 ft.), RP-CDHG30 (3.0 m/9.8 ft.), RP-CDHG50 (5.0 m/16.4 ft.), etc.

Basic connections

A Connecting to a television with an Audio/Video cable

Using the included Audio/Video cable, you can directly connect the player to your television set.

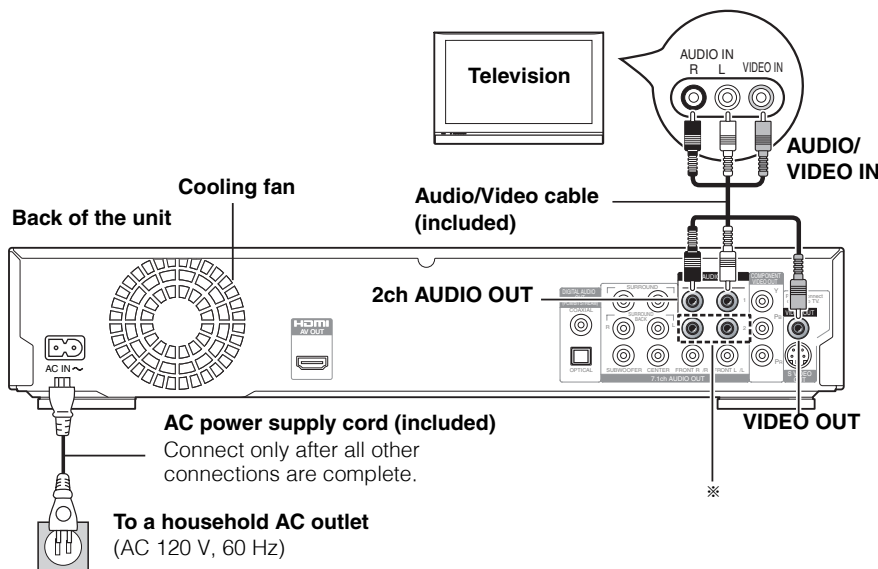

• High definition video cannot be output with this connection. Use connection **B** (⇒ below) or **C** (⇒ 9) for high definition video.



* With audio cables, you can connect these AUDIO OUT terminals to the 2-channel audio input terminals of an analog amplifier/receiver or system component to enjoy stereo sound.

To improve picture quality

- Use connections **D** or **E** (⇒ 9).

To enjoy an even richer sound

- Use connections **F** or **G** (⇒ 10). (Unplug the red and white plug.)

B Connecting to an HDMI compatible television

You can enjoy high quality, digital video and audio with just one HDMI cable.

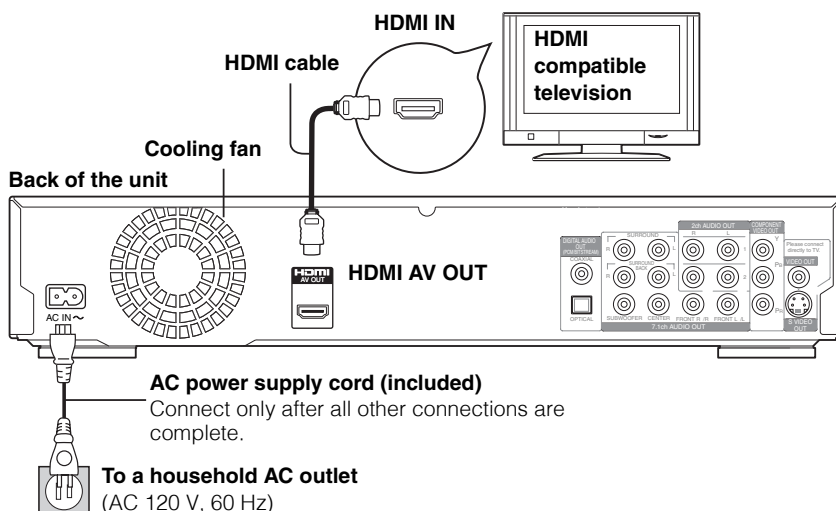

• When you use 1080p (1125p) video output, please use Panasonic HDMI cables 5 meters (16.4 ft.) or shorter.

NECESSARY SETTINGS

- From the Setup menu (⇒ 23), set "HDMI Video Mode" and "HDMI Audio Output" to "On".



To enjoy an even richer sound

- Use connections **F** or **G** (⇒ 10) additionally. In this case, set "HDMI Video Mode" to "On" and "HDMI Audio Output" to "Off" in the Setup menu (⇒ 23).

With this connection, you can use EZ Sync "HDAVI Control"

- See page 18 for the details.

Ⓒ Connecting to an HDMI compatible television and HDMI compatible amplifier/receiver

You can connect the player to your HDMI compatible amplifier/receiver with an HDMI cable to enjoy digital surround sound along with high quality digital video. Using an additional HDMI cable, you can connect the amplifier/receiver to your HDMI compatible television.

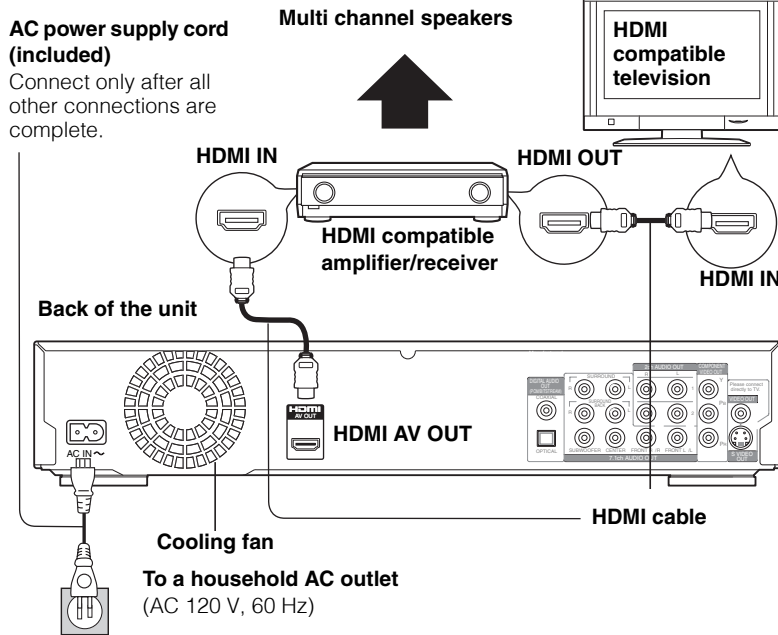

NOTE

- This unit comes equipped with a Dolby Digital Plus, Dolby TrueHD and DTS-HD* decoder. When connected to a compatible amplifier/receiver using the HDMI AV OUT terminal, you can enjoy surround sound recorded with Dolby Digital Plus, Dolby TrueHD or DTS-HD.
- *This unit supports DTS-HD High Resolution Audio, however it does not support DTS-HD Master Audio. DTS Digital Surround will be used as an alternative.
- When you use 1080p (1125p) video output, please use Panasonic HDMI cables 5 meters (16.4 ft.) or shorter.

NECESSARY SETTINGS

- From the Setup menu (➔ 23), set "HDMI Video Mode" and "HDMI Audio Output" to "On"
- If the speaker setup cannot be completed on the amplifier/receiver, change multi channel speaker settings by selecting "Multi -channel" in "Speaker" of "Connection" tab (➔ 23).
- If connecting to an amplifier/receiver incompatible with HDCP (➔ 29, Glossary), copy-protected DVD-Audio cannot be output through the HDMI terminal. Connect to the amplifier/receiver with audio cables (red and white), coaxial cable, or optical digital audio cable (➔ 10).

With this connection, you can use EZ Sync "HDAVI Control"

- See page 18 for the details.

Getting started

Connection methods for using other video terminals

Ⓓ With S VIDEO IN

The S VIDEO OUT terminal achieves a more vivid picture than the VIDEO OUT terminal.

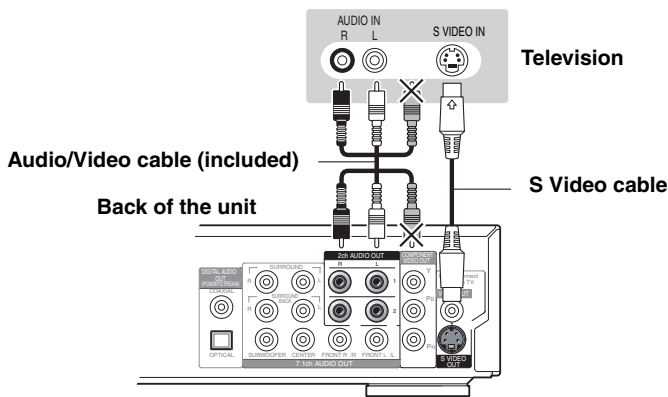

NOTE

- High definition video cannot be output with this connection. Use connection Ⓔ (➔ 8) or Ⓒ (➔ above) for high definition video.

- Unplug the yellow plug of Audio/Video cable.
- Actual video quality depends on the television.

Ⓔ With COMPONENT VIDEO IN

These terminals can be used for either interlace or progressive output (➔ 29, Glossary) and provide a purer picture than the S VIDEO OUT terminal.

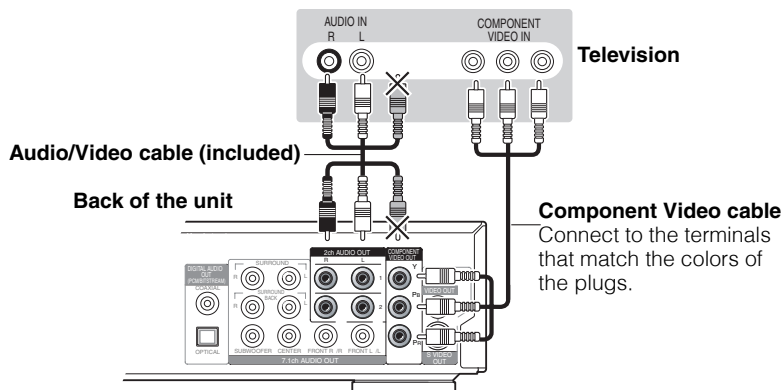

NOTE

- Select "Darker" from the "Black Level Control" (➔ 22, "Video" tab).
- Unplug the yellow plug of Audio/Video cable.

Regarding the high definition video output

- Some discs prohibit high definition video output from COMPONENT VIDEO OUT terminals. In this case, video resolution is converted and output as 480p.

To enjoy high definition/progressive video

- Connect to a progressive compatible television.
- From the Setup menu (➔ 22), select "480p", "720p" or "1080i" in "Component Video Resolution" of "Connection" tab.
- From the Setup menu (➔ 23), set "HDMI Video Mode" to "Off". Otherwise, the video is output as 480i.

Connecting an amplifier/receiver (excluding HDMI connection)

F Connecting to an amplifier/receiver with 7.1ch/5.1ch AUDIO IN terminal

You can enjoy surround sound using the 7.1ch AUDIO OUT terminals. The 7.1ch AUDIO OUT terminals offer you another option for enjoying surround sound.

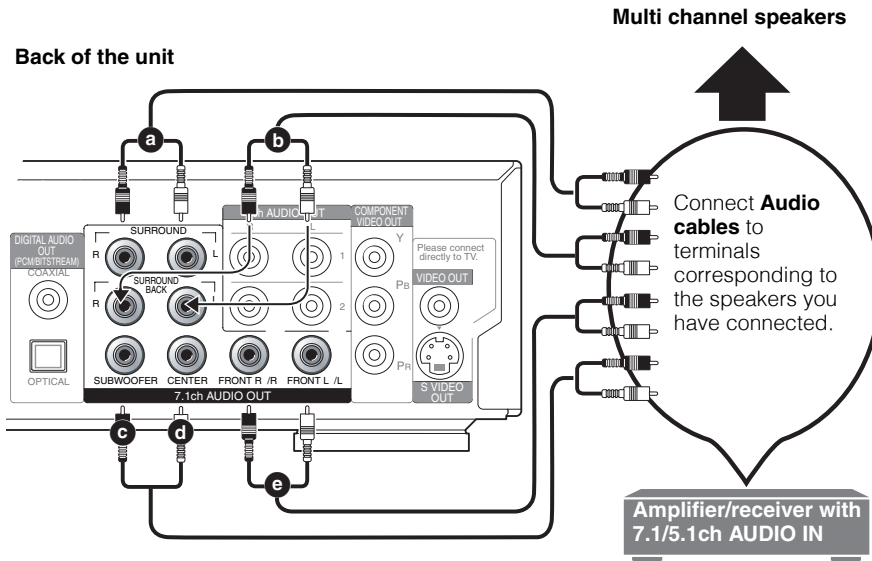

Cable connections

- a Surround speaker (L/R)
- b Surround back speaker (L/R)
(Not necessary when connecting to 5.1 channel AUDIO IN)
- c Subwoofer
- d Center speaker
- e Front speaker (L/R)



NOTE

- This unit comes equipped with a Dolby Digital Plus, Dolby TrueHD and DTS-HD* decoder. When connected to a compatible amplifier/receiver using the 7.1ch AUDIO OUT terminals, you can enjoy surround sound recorded with Dolby Digital Plus, Dolby TrueHD or DTS-HD.
- * This unit supports DTS-HD High Resolution Audio, however it does not support DTS-HD Master Audio. DTS Digital Surround will be used as an alternative.
- This unit supports playback of DVD-Video discs in surround sound up to 5.1 channels.
- Depending on how the disc was recorded, the audio may not be output properly on the number of channels desired.

NECESSARY SETTINGS

- If the speaker setup cannot be completed on the amplifier/receiver, change multi channel speaker settings by selecting "Multi-channel" in "Speaker" of "Connection" tab (► 23).

Only when this unit is connected to an HDMI compatible television (► 8, 9)

- From the Setup menu (► 23), set "HDMI Audio Output" to "Off". Otherwise, audio is output as two channels only, and also output from the television's speakers.

G Connecting to an amplifier/receiver with DIGITAL AUDIO IN terminal

You can enjoy surround sound using the DIGITAL AUDIO OUT terminals. The DIGITAL AUDIO OUT terminals offer you another option for enjoying surround sound.

With COAXIAL IN

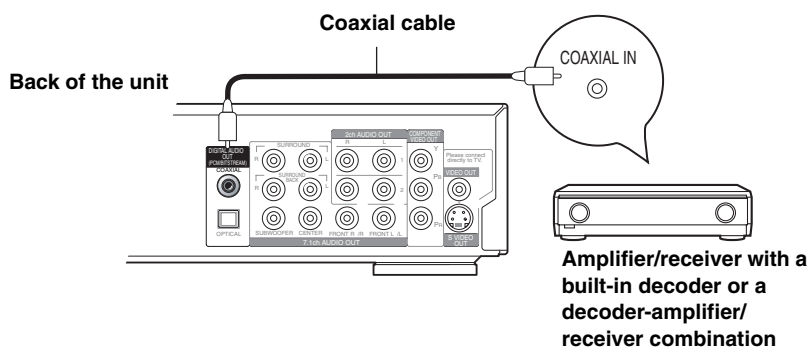

NOTE

- You cannot use DTS Digital Surround decoders (► 29, Glossary) incompatible with DVD.
- Even if using this connection, output will be only 2 channels when playing DVD-Audio. To enjoy multi-channel surround sound, use connections G (► 9) or F (► above).

NECESSARY SETTINGS

- Change the settings in "Digital Audio Output" (► 22).

Only when this unit is connected to an HDMI compatible television (► 8, 9)

- From the Setup menu (► 23), set "HDMI Audio Output" to "Off". Otherwise, the sound may not be output with the desired settings.

With OPTICAL IN

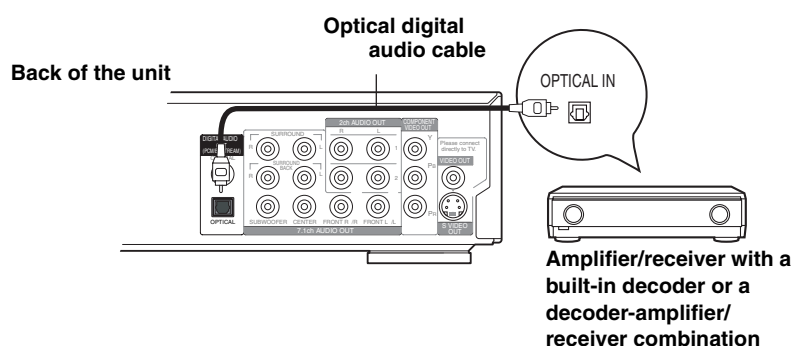

Easy Setting

After connecting your new player and pressing the power button, a screen will appear prompting you to perform setup for the basic settings. Please follow the guide and perform setup.

Preparation

Turn on the television and select the appropriate video input on the television.

1 Press [⏻ BD POWER].

Setup screen appears.

2 Follow the on-screen instructions and make the settings with [▲, ▼, ◀, ▶] and [ENTER].

"On-screen Language", "TV Aspect" and "Speaker" are set. You can also change their settings individually ("Display" and "Connection" tab ► 22-23).

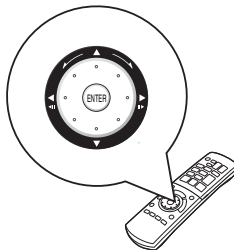

TIPS

- You can perform this setup anytime by selecting "Easy Setting" in Setup menu (► 21, "Setup" tab).

Remote control setting

Setting the television operation

You can configure the remote control TV operation buttons to turn the television on/off, change the television input mode, select the television channel and change the television volume.

Point the remote control at the television.

1 While pressing [RETURN], enter the code with the numbered buttons.

e.g., 01: [0] ► [1]

2 Test by turning on the television and changing channels.



NOTE

- If your television brand has more than one code listed, select the one that allows correct operation.
- If your television brand is not listed or if the code listed for your television does not allow control of your television, this remote control is not compatible with your television. Use the television's remote control.

Manufacturer and Code No

Panasonic		PHILIPS (RC-5)	03
National	01/02	RCA	05
QUASAR		SAMSUNG	14/18/19
FISHER	10	SANYO	10
GE	05	SHARP	06/07
GOLDSTAR	15/16/17	SONY	08
HITACHI	12	SYLVANIA	03
JVC	11	THOMSON	05
LG	15/16/17	TOSHIBA	09
MAGNAVOX	03	ZENITH	04
mitsubishi	13		

When other Panasonic products respond to this remote control

Change the remote control code on the main unit and the remote control (the two must match) if you place other Panasonic products close together. Use "1", the factory set code, under normal circumstances.

1 Press [SETUP].

2 Press [▲, ▼] to select "Setup" and press [▶].

3 Press [▲, ▼] to select "Remote Control Code" and press [ENTER].

4 Press [▲, ▼] to select the code (1, 2, or 3) and press [ENTER].



5 To change the code on the remote control

While pressing [ENTER], press and hold the numbered button ([1], [2] or [3]) for more than 2 seconds.

6 Press [ENTER].



NOTE

When the following indicator appears on the unit's display and you are unable to operate the unit



The unit's remote control code

- Press and hold [ENTER] and the indicated number button at the same time for more than 2 seconds.

Basic play

Instructions for operations are generally described using the remote control in this manual.

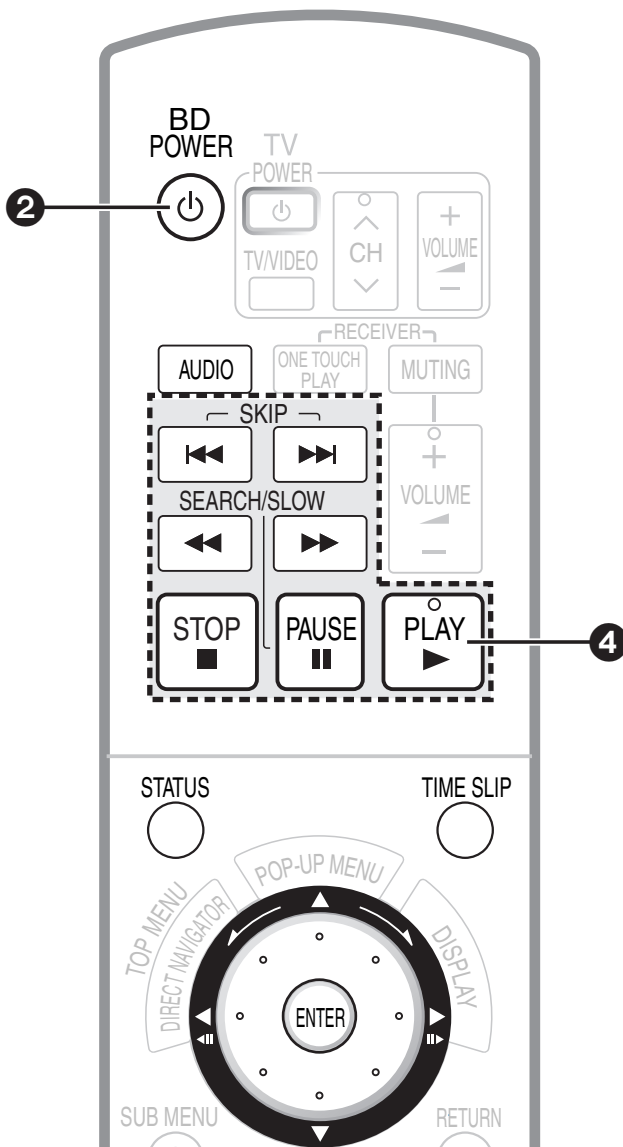
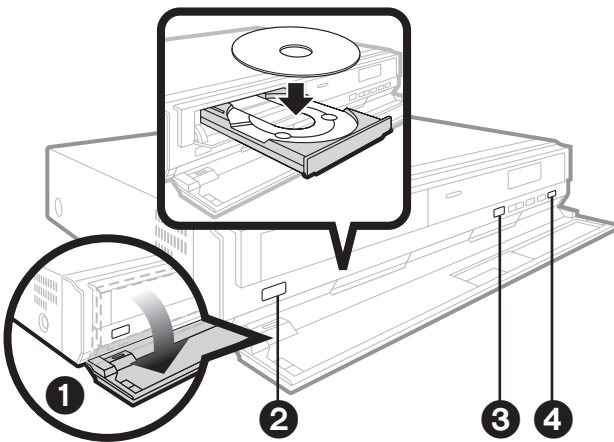

Start play

Preparation

Turn on the television and select the appropriate video input on the television with the remote control for the television.

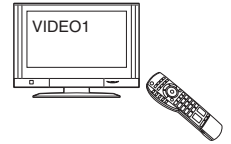

- 1 **Open the front cover.**
- 2 **Press [POWER] to turn on the unit.**
- 3 **Press [OPEN/CLOSE] to open the disc tray and load the disc.**
 - Load double-sided discs so the label for the side you want to play is facing up.
 - DVD-RAM: Remove discs from their cartridges before use.
- 4 **Press [PLAY] to start play.**
 - When a menu screen appears
 - ➔ 15, Showing disc menu, step 2
 - If the screen prompting you to use the color buttons appears, continue to operate with the color buttons on the remote control.

Basic playback control



Start play

- It is not possible to play continuously from one side of a double-sided disc to the other. You will need to eject the disc and turn it over.



Stop

The stopped position is memorized.

Resume play function

Press [PLAY] to restart from this position.

- The disc position is cleared if the tray is opened or [STOP] is pressed several times.
- **DVD-A CD VCD MP3**: The position is cleared if the unit is turned off.

Note

DISCS CONTINUE TO ROTATE WHILE MENUS ARE DISPLAYED. Press [STOP] when you have finished playback to protect the unit's motor, your television screen and so on.



Pause

- Press [PAUSE] again or [PLAY] to restart play.



Search/Slow-motion

Search (During play)

The speed increases up to 5 steps.

- Press [PLAY] to revert to normal playback speed.
- **BD-V**: Audio is not heard during all levels of search.
- **DVD-V DVD-VR VCD**: Audio is heard during first level of forward search.
- **DVD-A CD MP3**: Audio is heard during all levels of search.

Slow-motion (During pause)

The speed increases up to 5 steps.

- **BD-V VCD**: Forward direction [SEARCH/SLOW] only.
- Press [PLAY] to revert to normal playback speed.

You can also use Multi-jog to Search/Slow-motion. (➔ 13, Search/Slow-motion)



Skip

- Skip to the title, chapter or track you want to play.
- Each press increases the number of skips.

Other operations during play



Open remote control cover



Starting from a selected item

Play starts from the selected title, chapter or track.

MP3 JPEG

e.g., 5: [0] → [0] → [5]
15: [0] → [1] → [5]

Other discs (You can select a track with DVD-Audio.)

e.g., 5: [0] → [5]
15: [1] → [5]

DVD-A Selecting groups

While stopped (screen saver is displayed on the television ► right)

e.g., 5: [5]

- This works only when stopped (screen saver is displayed on the television ► right) with some discs.

VCD (with playback control)

If you press the numbered buttons while stopped (the above screen saver is displayed on the television) you can cancel playback control. (Elapsed play time appears on the unit's display.)



Frame-by-frame

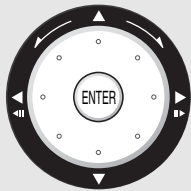

While paused, press [◀] (◀◀) or [▶] (▶▶).

Each press shows the next frame.

- Press and hold to change in succession forward or backward.
- Press [▶] (PLAY) to revert to normal playback speed.

BD-V VCD Forward direction [▶] (▶▶) only.

BD-V This function does not work while the BD-J is being executed.

Search/Slow-motion

Forward search: During play, turn the wheel right.

Forward slow-motion: During pause, turn the wheel right.

Backward search: During play, turn the wheel left.

Backward slow-motion: During pause, turn the wheel left.

- Press [▶] (PLAY) to revert to normal playback speed.
- Turn the Multi-jog lightly. If you press it strongly when turning it, [▲, ▼, ◀, ▶] may be mistakenly activated.

- The wheel operation can be turned off. Set the "Multi-jog Setting" to "Off" (► 21, "Setup" tab).

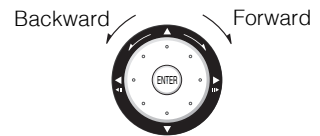

TIME SLIP



Skipping the specified time (Time Slip) **BD-V DVD-VR**

1 Press [TIME SLIP].

2 Press [▲, ▼] to select the time and press [ENTER].

Play skips the specified time.

- Each time you press [▲, ▼], the time increases [▲] or decreases [▼] by 1 minute intervals. (Press and hold for 10-minute intervals.)
- The display automatically disappears after approximately 5 seconds.

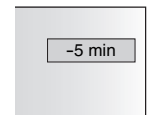

STATUS



Status messages

The Status display gives you information about what is currently being played. Each time you press the [STATUS] button, the information displayed will change.

e.g. **BD-V**

Type of disc Play status

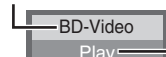

T: Title/Track PL: Playlist
C: Chapter PBC: Playback control
G: Group
Items change depending on the disc played.

Elapsed time

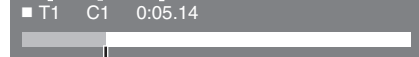

Current position

No display

Depending on the kind of disc or the playback status, this display may not appear.

AUDIO

Changing audio during play

DVD-VR VCD

Stereo → Mono L → Mono R

DVD-VR (Bilingual)

Main Audio → SAP Audio

BD-V DVD-V DVD-A

You can change the audio channel number each time you press the button. This allows you to change things like the soundtrack language (► 19, Soundtrack).

e.g., "Stereo" is selected

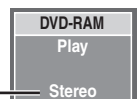

e.g., English is selected.

Adjusting picture and sound quality

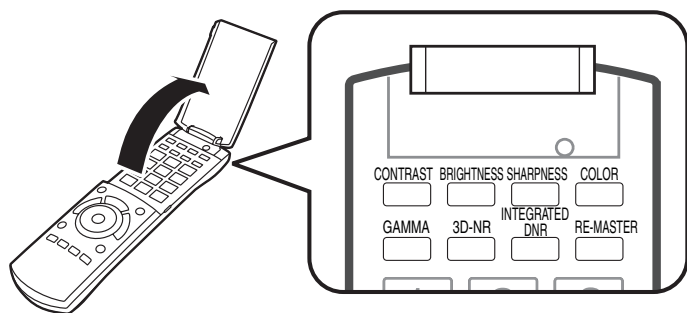

Adjusting the picture

During video playback, pressing each of the following buttons will display the corresponding on-screen adjustment as shown in the illustration on the right. Adjustments are made in units of 1 each time the button is pressed. You can also make the same adjustments by pressing the left or right cursor keys.



Press the buttons below.



Contrast
Increases the contrast between light and dark parts of the picture (-7 to +7).



Gamma
Adjusts the brightness of dark portions of the screen (0 to +5).



Brightness
Brightens the picture (0 to +15).



3D-NR (Noise Reduction)
Reduces the rough noise in the background to give a greater feeling of depth (0 to +4).



Sharpness
Adjusts the sharpness of the edges of the horizontal lines (-6 to +6).

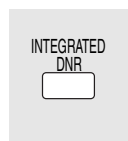

Integrated DNR (Digital Noise Reduction)
Smooths block noise and reduces the smudging that appears around contrasting sections of the picture (0 to +3).



Color
Adjusts the shade of the picture's color (-7 to +7).

Reproducing more natural audio

The purpose of the Re-master function is to add audio to portions of a track where audio was not recorded, or to reproduce audio signals that were lost in a natural, rich manner.



Re-master
DVD-V* DVD-VR* CD

• **During multi-channel output**

This feature reproduces the frequencies lost during recording to give you a sound closer to the original.

• **During 2 ch output**

This feature gives you a more natural sound by adding higher frequency signals not recorded on the track. (For example, playing DVD-Video recorded with 48 kHz at 96 kHz.)

Press [RE-MASTER] to select "1", "2" or "3".

"Re-Master" has three different modes. Select the one that you like best.

Setting	When playing LPCM sound Type of music	Other types of sound Effect level
1	High tempo (e.g., pop and rock)	Light
2	Various tempos (e.g., jazz)	Medium
3	Low tempo (e.g., classical)	Strong
Off	Off	Off



NOTE

* Tracks recorded with 48 kHz only

- This may not work depending on the disc's recording.
- When connecting with DIGITAL AUDIO OUT terminal, the actual output sampling frequency depends on "Digital Audio Output" setting in "Audio" tab (➡ 22).

Operations using menu screen

Showing Pop-up menu **BD-V**

The Pop-up menu is a special feature available with some BD-Video discs. This menu may be different depending on discs, and selectable items may differ as well. For more information on how to operate the menu on your BD-Video discs please read the operating instructions that came with the disc.

1 Press [POP-UP MENU].

e.g.,

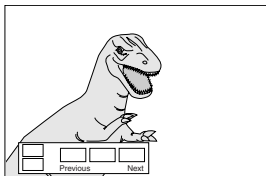

2 Press [▲, ▼, ◀, ▶] to select the item and press [ENTER].



- Pop-up menu also appears by pressing [SUB MENU] and selecting "Pop-up menu".

To exit the screen

- Press [POP-UP MENU].

Showing disc menu **BD-V DVD-V DVD-A VCD***

This menu may be different depending on discs, and selectable items may differ as well. For more information on how to operate the menu on your discs, please read the operating instructions that came with the disc.

1 Press [TOP MENU].

VCD* Press [RETURN] while playing.

e.g.,

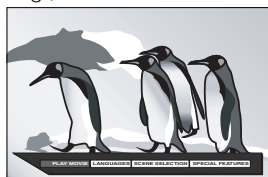

2 Press [▲, ▼, ◀, ▶] to select the item and press [ENTER].

VCD* Press the numbered buttons to select the item.

e.g., 5: [0] → [5] 15: [1] → [5]



* With playback control

Using the sub menu to show menu screen

- 1 Press [SUB MENU].
Sub menu appears on the screen.
- 2 Press [▲, ▼] to select "Pop-up menu", "Top menu" or "Menu" and press [ENTER].
Items differ depending on the disc type playing.

To exit the screen

- Press [TOP MENU].

Playing programs with the menu screen **DVD-VR**

1 Press [DIRECT NAVIGATOR].

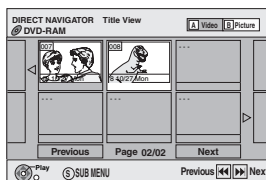

2 Press [▲, ▼, ◀, ▶] to select the program and press [ENTER].

Using the sub menu

- 1 While the above screen is displayed
Press [SUB MENU].
The sub menu appears.

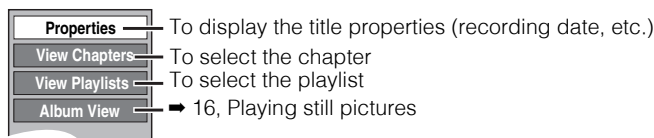

- 2 Press [▲, ▼] to select the item and press [ENTER].
- 3 Only when "View Chapters" or "View Playlists" is selected
Press [▲, ▼, ◀, ▶] to select the item and press [ENTER].



- Press [◀◀, ▶▶] to show other pages.

- If "Album View" or "Picture View" screen is displayed, press the "A" button to switch to the "Title View" screen.

To exit the screen

- Press [DIRECT NAVIGATOR].

Playing MP3 files and still pictures

Playing MP3 files **MP3**

You can play MP3 files recorded onto a CD-R/RW.

1 Press [DIRECT NAVIGATOR].

G: Group No.

T: Track No. in the group

Total: Track No./Total tracks in all groups

- Files are treated as tracks and folders are treated as groups.

"⏮" indicates the track currently playing.

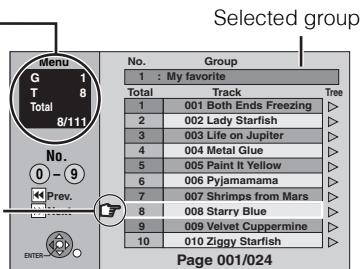

2 Press [▲, ▼] to select the track and press [ENTER].

Play starts on the selected track.

Showing list of groups

- While the file list (above) is displayed Press [▶] while a track is highlighted to display the tree screen.

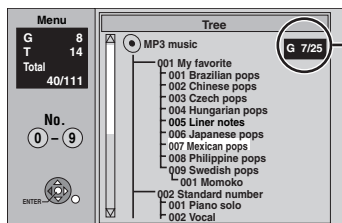

Selected group No. /Total groups
If the group has no track, "--" is displayed as group number.

- Press [▲, ▼] to select a group and press [ENTER].
The file list for the group appears.



When the JPEG Menu is displayed, perform steps below.

- Press [DIRECT NAVIGATOR] to exit menu screen.
- Set "Mixed Disc—Audio & Pictures" to "MP3" (→ 21, "Disc" tab).



You can also select the track with the numbered buttons. (→ 13, Starting from a selected item)

- Press [◀, ▶] to show other pages.

To exit the screen

Press [DIRECT NAVIGATOR].



You cannot select groups that contain no compatible files.



To return to the previous screen

Press [RETURN].

Playing still pictures **JPEG**

You can play still pictures recorded onto a DVD-RAM and CD-R/RW.

1 Press [DIRECT NAVIGATOR].

DVD-RAM

"Album View" screen is displayed

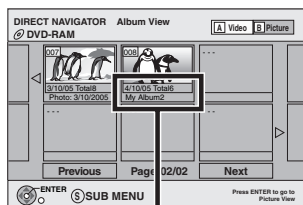

Recording date of the first picture in the album, number of pictures and album name.

CD-R/RW

"Picture View" screen is displayed

→ Go step 3

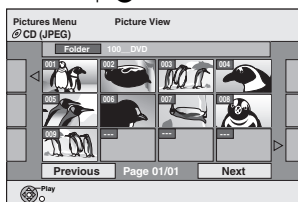

2 Press [▲, ▼, ◀, ▶] to select the album and press [ENTER].

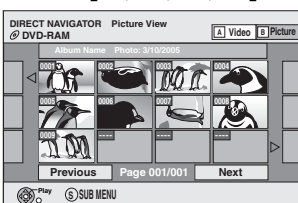

3 Press [▲, ▼, ◀, ▶] to select the still picture and press [ENTER].



DVD-RAM

When "Title View" screen is displayed, press the "B" button to switch to the "Album View" screen.

CD-R/RW

When the MP3 Menu is displayed, perform steps below.

- Press [DIRECT NAVIGATOR] to exit menu screen.
- Set "Mixed Disc—Audio & Pictures" to "Pictures" (→ 21, "Disc" tab).



Press [◀, ▶] to display the previous or next still picture.
Useful functions during still picture play (→ 17).

- Select the still pictures in another folder (→ 17)
- You can also select the still pictures with the numbered buttons. (→ 13, Starting from a selected item)

To return to the previous screen

Press [RETURN].

To exit the screen

Press [DIRECT NAVIGATOR].

Useful functions during still picture play

Start Slideshow

You can display still pictures one by one at a constant interval.

- ① While the "Album View" (DVD-RAM) or "Picture View" (CD-R/RW) screen is displayed
Press [**▲**, **▼**, **◀**, **▶**] to select the album (for DVD-RAM) or "Folder" (for CD-R/RW) and press [SUB MENU].
- ② Press [**▲**, **▼**] to select "Start Slideshow" and press [ENTER].
 - DVD-RAM only
You can also start slideshow by pressing [**▶**] (PLAY) after selecting the album

Slideshow settings

To change the display interval

- ① While the "Album View" (DVD-RAM) or "Picture View" (CD-R/RW) screen is displayed
Press [**▲**, **▼**, **◀**, **▶**] to select the album (for DVD-RAM) or "Folder" (for CD-R/RW) and press [SUB MENU].
- ② Press [**▲**, **▼**] to select "Slideshow settings" and press [ENTER].
- ③ Press [**▲**, **▼**] to select "Display Interval" and press [**◀**, **▶**] to select the desired interval (0-30 seconds) and press [ENTER].

To repeat slideshow

After step ② above

Press [**▲**, **▼**] to select "Repeat Play" and press [**◀**, **▶**] to select "On" or "Off" and press [ENTER].

Rotate

- ① While playing
Press [SUB MENU].
- ② Press [**▲**, **▼**] to select "Rotate Right" or "Rotate Left" and press [ENTER].
 - The rotation information will not be stored.

Zoom in/Zoom out

This function is only available for still pictures smaller than 640×480 pixels.

- ① While playing
Press [SUB MENU].
- ② Press [**▲**, **▼**] to select "Zoom in" and press [ENTER].
 - To return the picture to its original size, press [**▲**, **▼**] to select "Zoom out" in step ② and press [ENTER].
 - When zooming in, the picture may be cut off.
 - The enlargement information will not be stored.

To select the still pictures in another folder

DVD-RAM

To switch to another higher folder

(Only if there is a multiple number of higher folders recognizable)

- ① While the "Album View" screen is displayed
Press [SUB MENU].
- ② Press [**▲**, **▼**] to select "Select Root folder" and press [ENTER].
- ③ Press [**◀**, **▶**] to select the higher folder and press [ENTER].

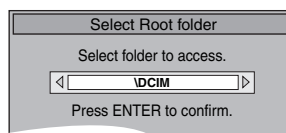

CD-R/RW

- ① While the "Picture View" screen is displayed
Press [**▲**, **▼**, **◀**, **▶**] to select "Folder" and press [ENTER].
- ② Press [**▲**, **▼**] to select the folder and press [ENTER].



To show the picture properties

While playing

Press [STATUS] twice.

To exit the picture properties screen, press [STATUS].

e.g. JPEG on DVD-RAM

Shooting date



Linked operations with the TV (EZ Sync™ “HDAVI Control™”)

What is EZ Sync “HDAVI Control”?

EZ Sync “HDAVI Control” is a convenient function that offers linked operations of this unit, and a Panasonic TV (VIERA) or amplifier/receiver under “HDAVI Control”. You can use this function by connecting the equipment with the HDMI cable. See the operating instructions for connected equipment for operational details.

Preparation

1. Connect this unit to your TV or amplifier/receiver with an HDMI cable (➡ 8–9).
2. Set “Ctrl with HDMI” to “On” (➡ 23).
(The default setting is “On”.)
3. Set the “HDAVI Control” operations on the connected equipment (e.g., TV).
 - When using HDMI2 terminal of VIERA as “HDAVI Control”, set the input channel to HDMI2 on VIERA.
4. Turn on all “HDAVI Control” compatible equipment and select this unit’s input channel on the connected TV so that the “HDAVI Control” function works properly.
Also when the connection or settings are changed, repeat this procedure.

- EZ Sync “HDAVI Control”, based on the control functions provided by HDMI which is an industry standard known as HDMI CEC (Consumer Electronics Control), is a unique function that we have developed and added. As such, its operation with other manufacturers’ equipment that supports HDMI CEC cannot be guaranteed.
- This unit supports “HDAVI Control 2” function. “HDAVI Control 2” is the newest standard (current as of February, 2007) for Panasonic’s HDAVI Control compatible equipment. This standard is compatible with Panasonic’s conventional HDAVI equipment.
- It is recommended that you use Panasonic’s HDMI cable.
Recommended part number:
RP-CDHG15 (1.5 m/4.9 ft.), RP-CDHG30 (3.0 m/9.8 ft.), RP-CDHG50 (5.0 m/16.4 ft.), etc.
- Non-HDMI-compliant cables cannot be utilized.

What you can do with “HDAVI Control”

One touch play

You can turn on this unit, television and amplifier/receiver, and start playing the disc in the play position with a single press of a button.

Press [ONE TOUCH PLAY].

- When operating, point the remote control at the remote control signal sensor on the main unit.
- When [ONE TOUCH PLAY] or [▶] (PLAY) is pressed on this unit for “Automatic input switching” or “Power on link”, the playback image is not immediately displayed on the screen and it may not be possible to watch the contents from where playback started. In this case, press [◀◀] or [◀◀] to go back to where playback started.

Automatic input switching

When the following operations are performed the television will automatically switch the input channel and displays the corresponding action.

- When play starts on the unit
- When an action that uses the display screen is performed (e.g., Direct Navigator screen)

Power on link

When the television is off and the following operations are performed, the television will automatically turn on and displays the corresponding action.

- When play starts on the unit
- When an action that uses the display screen is performed (e.g., Direct Navigator screen)

Power off link

All connected equipment compatible with “HDAVI Control” including this unit automatically turns off when you switch the television off.

- This unit automatically turns off even during playback or any other operation.
- Only this unit turns off when you press the power button of the unit or the remote control for shutting it down. Other connected equipment compatible with “HDAVI Control” stays on.

Easy control only with VIERA remote control

If you connect this unit to the TV that has “HDAVI Control 2” function with an HDMI cable, you can operate this unit using the following buttons on the TV remote control.

[▲], [▼], [◀], [▶], [OK], [RETURN], [SUB MENU] and colored buttons.

Use the remote control for this unit to operate any other buttons (numbered buttons, etc.) that are not listed above.

- Refer to the TV operating instructions for operating TV.

Using the SUB MENU window to operate this unit

By using the TV remote control, you can play discs using the “Control Panel” (➡ below) and display the Top Menu (for BD-Video and DVD-Video) or Pop-up Menu (for BD-Video).

1 Press [SUB MENU].

This can also be displayed by using the VIERA menu screen.
e.g.

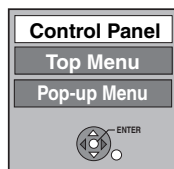

Control Panel	Control Panel is displayed (➡ right).
Top Menu BD-V DVD-V	Top menu is displayed (➡ 15).
Menu DVD-V	Menu is displayed (➡ 15).
Pop-up Menu BD-V	Pop-up menu is displayed (➡ 15).
Rotate Right JPEG	Rotate the still picture (➡ 17).
Rotate Left JPEG	
Zoom in JPEG	Enlarge or shrink the still picture (➡17).
Zoom out JPEG	

Using the Control Panel

Using the Control Panel, you can operate search backward, search forward, stop, etc, with the TV remote control.

Perform steps 1 and 2 of “Using the SUB MENU window to operate this unit” (➡ left).

The Control Panel is displayed (➡ right).

- When playing BD-Video or DVD-Video, etc.
 - [▲]: Pause, [▼]: Stop, [◀]: Search backward, [▶]: Search forward, [OK]: Play.
- While playing still pictures
 - [▼]: Stop, [◀]: View previous picture, [▶]: View next picture.

Control Panel

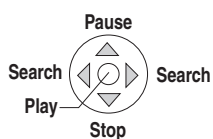

When you want to leave the TV on and set only this unit to standby mode

Press [⏻ BD POWER] on this unit’s remote control and set to standby mode.

When not using “HDAVI Control”

Set “Ctrl with HDMI” in the Setup menu to “Off” (➡ 23)

Note You cannot use the SUB MENU while the Top Menu for BD-Video or DVD-Video is displayed.

2 Select an item then press [OK].

Changing settings with the On-screen menu

What is On-screen menu?

The On-screen menu is a menu that appears on screen, regardless of whether a disc is being played or stopped, when [DISPLAY] is pressed. The On-screen menu allows you to turn subtitles on or off, switch audio tracks, and change a variety of other settings.

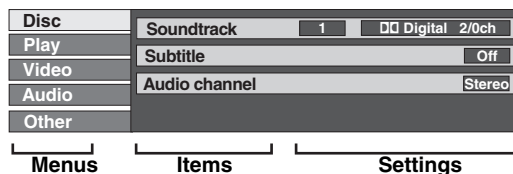

On-screen menu operations

- 1 Press [DISPLAY] to show On-screen menu.
- 2 Press [▲, ▼] to select the menu and press [▶].
- 3 Press [▲, ▼] to select the item and press [▶].
- 4 Press [▲, ▼] to select the setting.



• Depending on the condition of the unit (playing, stopped, etc.) and disc contents, there may be some items that you cannot select or change.



• Some items can be changed by pressing [ENTER].
To exit the On-screen menu
 Press [DISPLAY].

What you can change with On-screen menu

Menus	Items	Settings and details
Disc	Soundtrack*	BD-V DVD-V DVD-A Select the audio and language (➡ below, Language, Audio attribute). DVD-VR The disc's audio attributes appear (➡ below, Audio attribute). VCD (SVCD) Select the soundtrack number. Soundtrack numbers are displayed even when there is only one audio type.
	Subtitle*	BD-V DVD-V Turn the subtitle on/off and select the language (➡ below, Language). DVD-VR (Only discs that contain subtitle on/off information) Turn the subtitle on/off. VCD (SVCD) Turn the subtitle on/off and select the subtitle number. Subtitle numbers are displayed even if there are not multiple subtitles.
	Subtitle Style	BD-V Select the subtitle style.
	PBC	VCD Indicates whether menu play (playback control) is on or off.
	Audio channel	DVD-VR VCD ➡ 13, Changing audio during play
	Angle*	BD-V DVD-V Change the number to select an angle.
	Still-P (Still picture)	DVD-A Selects the play method for still pictures. • Slide Show: Plays according to the default order on the disc. • Page: Select the still picture number and play. • Random: Plays in random order. • Return: Returns to the default still picture on the disc.

* You may have to use the menus on the disc to make changes (➡ 15).

Language		
ENG: English	DAN: Danish	THA: Thai
FRA: French	POR: Portuguese	POL: Polish
DEU: German	RUS: Russian	CES: Czech
ITA: Italian	JPN: Japanese	SLK: Slovak
ESP: Spanish	CHI: Chinese	HUN: Hungarian
NLD: Dutch	KOR: Korean	FIN: Finnish
SVE: Swedish	MAL: Malay	*: Others
NOR: Norwegian	VIE: Vietnamese	

Audio attribute	
LPCM/PPCM/☐☐ Digital/☐☐ Digital +/ ☐☐ TrueHD/DTS-HD/DTS/MPEG	Signal type
ch (channel)	Number of channels
k (kHz)	Sampling frequency
b (bit)	Number of bits

(Continued on the next page)

Playback

Settings

Menus	Items	Settings and details
Play	Repeat play	(Only when the elapsed time is being displayed on the unit display.) Selects the item which you want to repeat. The items displayed differ depending on the type of disc. <ul style="list-style-type: none"> ●All Entire disc ●Chapter Chapter ●Group Entire group ●PL Playlist ●Title Title (DVD-Video, etc.) ●Track Track ●Off Select "Off" to cancel.
		BD-V DVD-V DVD-VR VCD Select the picture quality mode during play. <ul style="list-style-type: none"> ●Normal: Default setting ●Soft: Soft picture with fewer video artifacts ●Fine: Details are sharper ●Cinema: Mellows movies, enhances detail in dark scenes. ●User: You can make further adjustments. Press [▲, ▼, ◀, ▶] to select "Picture adjustment" and press [ENTER]. If the video adjustment buttons on the remote control are used, the setting is automatically changed to "User". Contrast: Brightness: Sharpness: Color: Gamma: 3D Noise Reduction: Integrated DNR: → For details, see page 14
		DNR BD-V DVD-V DVD-VR VCD Reduces mosaic-like distortion and picture degradation. <ul style="list-style-type: none"> ●On ●Off
		Progressive* Select "On" to enable progressive output. <ul style="list-style-type: none"> ●Depending on the type of television used, the video may be stretched horizontally when video is output in progressive mode. When this occurs, select "Off" and the video will then be output as "480i". ●This setting will be fixed to "On" if you connect with an HDMI cable and set "HDMI Video Mode" to "On" (→ 23, "HDMI" tab). ●When progressive output is on, closed captions cannot be displayed.
Video	Picture	Transfer* [When "Progressive" (→ above) is set to "On".] Select the method of conversion for progressive output to suit the type of material being played (→ 29, Glossary, Film and video). <ul style="list-style-type: none"> ●Auto1 (normal): Automatically detects the film and video content, and appropriately converts it. ●Auto2: In addition to "Auto1", automatically detects film contents with different frame rates and appropriately converts it. ●Video: Select when using "Auto1" and "Auto2", and the content is distorted.
		4:3 Aspect BD-V DVD-V DVD-VR VCD You can select how images made for 4:3 aspect screens are displayed on a 16:9 aspect television. <ul style="list-style-type: none"> ●Zoom: Makes 4:3 letterbox video expand to full screen on a wide screen television (16:9). ●Normal: The picture is displayed as a 4:3 ratio image in the center of the screen.
Audio	V. Surround Sound	DVD-V DVD-VR (Dolby Digital with 2 channels or more only) Enjoy a surround-like effect if you are using two front speakers only. <ul style="list-style-type: none"> ●Emphasis ●Natural ●Off <ul style="list-style-type: none"> ●Turn V. Surround Sound off if it causes distortion. ●Do not use in combination with surround effects on other equipment. ●V. Surround Sound does not work for bilingual recordings.
		Dialog Enhancer BD-V (3 channels or more only, including a center channel) DVD-V DVD-VR (Dolby Digital with 3 channels or more only, including a center channel) The volume of the center channel is raised to make dialog easier to hear. <ul style="list-style-type: none"> ●On ●Off
		Re-master DVD-V DVD-VR CD <ul style="list-style-type: none"> ●1-3, Off (→ 14, Reproducing more natural audio)
		Digital Filter When audio is output from 2ch or 7.1ch AUDIO OUT terminals (→8-10) <ul style="list-style-type: none"> ●Normal: A clear timbre. ●Slow: Gives music atmosphere, with softness and a feeling of depth.
Other	Position	Select the position of the On-screen menu. <ul style="list-style-type: none"> ●1 (Standard): Highest to ●5: Lowest

Changing the unit's settings

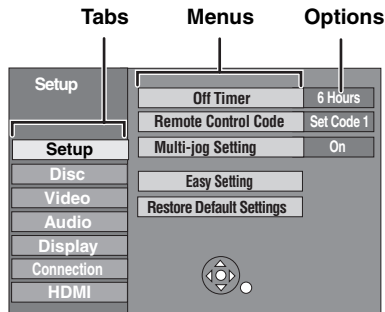

Setup menu operations

- 1 While stopped
Press [SETUP].
- 2 Press [▲, ▼] to select the tab and press [▶].
- 3 Press [▲, ▼] to select the menu and press [ENTER].
- 4 Press [▲, ▼] to select the option and press [ENTER].



• There may be differences in operation methods. If this happens, follow the on-screen instructions for the operation.







To return to the previous screen
Press [RETURN].

To exit the screen
Press [SETUP].

Summary of settings

The settings remain intact even if you switch the unit to standby.

Tabs	Menus	Options (Underlined items are the factory presets.)	
Setup	Off Timer Select how long the unit remains on when it is not being used.	• 2 Hours • <u>6 Hours</u> • Off	
	Remote Control Code (⇒ 11)	• <u>Set Code 1</u> • Set Code 2 • Set Code 3	
	Multi-jog Setting Select "Off" to turn the wheel operation off.	• <u>On</u> • Off	
	Easy Setting You can execute basic settings (On-screen Language, TV Aspect, Speaker setting).	• Yes • <u>No</u>	
	Restore Default Settings This returns all values in the Setup menu and the On-screen menu, except for "DVD-Video Ratings" and "Age limit for BD-Video viewing" to the default settings.	• Yes • <u>No</u>	
Disc	DVD-Video Ratings Set a ratings level to limit DVD-Video play.	• <u>8 No Limit:</u> All DVD-Video can be played. • 1 to 7: Prohibits play of DVD-Video with corresponding ratings recorded on them.	
	Age limit for BD-Video viewing Set an age limit of BD-Video play.	• <u>0 Lock All:</u> Prohibits play of all DVD-Video. • <u>Unlock Player</u> • Change Password • Change Level • Temporary Unlock	
	Play DVD-Audio in Video Mode Select "Video Mode (Video On)" to play DVD-Video content on some DVD-Audio.	• <u>No Limit:</u> All BD-Video can be played. • 0 to 254 year(s): Prohibits play of BD-Video with corresponding ratings recorded on them. • <u>Unlock Player</u> • Change Password • Change age limit for viewing • Temporary Unlock	
	Mixed Disc-Audio & Pictures When playing a CD-R/RW recorded with both MP3 and JPEG files, you can select which types of files you would like to give priority to.	• <u>Video Mode (Video On):</u> The setting returns to "Audio Mode (Video Off)" when you change the disc or turn the unit off. • <u>Audio Mode (Video Off)</u> • <u>MP3</u> • Pictures	
	Audio Language Choose the language for audio, subtitle and disc menus. BD-V DVD-V	• <u>English</u> • French • Spanish • Original: The original language of each disc will be selected. • Other ****	
	Subtitle Language	• <u>Automatic:</u> If the language selected for "Audio Language" is not available, subtitles of that language will automatically appear if available on that disc. • English • French • Spanish • Other ****	
	Menu Language	• <u>English</u> • French • Spanish • Other ****	
		• Enter a code (⇒ 28) with the numbered buttons when you select "Other ****".	

Tabs	Menus	Options (Underlined items are the factory presets.)
Video	Still Mode (paused video) <u>DVD-V</u> Select the type of picture shown when you pause playback (➡ 29, Frames and fields).	<ul style="list-style-type: none"> ● <u>Automatic</u> ● <u>Field</u>: Select if jittering occurs when "Automatic" is selected. (The picture is coarser.) ● <u>Frame</u>: Select if small text or fine patterns cannot be seen clearly when "Automatic" is selected. (The picture is clearer and finer.)
	Seamless Play Select the play mode between playlist chapter segments and partially deleted titles.	<ul style="list-style-type: none"> ● <u>On</u>: The chapters in playlists are played seamlessly. This does not work when there are several audio types included on the playlist. Additionally, the positioning of chapter segments may change slightly. ● <u>Off</u>: The points where chapters in playlists change are played accurately, but the picture may freeze for a moment.
	Black Level Control Select lighter or darker for adjusting the black level control to the desired setting for picture enhancement.	<ul style="list-style-type: none"> ● <u>Lighter</u>: When video is output from VIDEO OUT or S VIDEO OUT terminal. ● <u>Darker</u>: When video is output from COMPONENT VIDEO OUT terminal.
Audio	Dynamic Range Compression <u>BD-V</u> <u>DVD-V</u> (Dolby Digital, Dolby Digital Plus and Dolby TrueHD only) Change the dynamic range (➡ 29, Glossary) for late night viewing.	<ul style="list-style-type: none"> ● <u>On</u> ● <u>Off</u>
	Digital Audio Output Change the settings when you have connected equipment through this unit's digital audio out terminal (➡ 10).	
	<ul style="list-style-type: none"> ● Press [ENTER] to show the following settings. PCM Down Conversion Select how to output audio with a sampling frequency of 96 kHz or 88.2 kHz.	<ul style="list-style-type: none"> ● <u>On</u>: Signals are converted to 48 kHz or 44.1 kHz. (Choose when the connected equipment cannot process signals with sampling frequency of 96 kHz or 88.2 kHz.) ● <u>Off</u>: Signals are output as 96 kHz or 88.2 kHz. (Choose when the connected equipment can process signals with sampling frequency of 96 kHz or 88.2 kHz.)
	<ul style="list-style-type: none"> ● <u>BD-V</u> Refer to "BD-Video Function Sound" (➡ below). Dolby Digital  Select how to output the signal. If "Bitstream" is selected, the bitstream is output from the unit and the connected equipment decodes the signal.	<ul style="list-style-type: none"> ● <u>Bitstream</u>: When connecting to equipment displaying the Dolby Digital logo. ● <u>PCM</u>: When connecting to equipment not displaying the Dolby Digital logo.
	Dolby Digital Plus/ Dolby TrueHD   If "PCM" is selected, this unit decodes the signal and output it as 2 channel from DIGITAL AUDIO OUT terminal.	<ul style="list-style-type: none"> ● <u>Bitstream</u>: The bitstream signal of Dolby Digital is output. ● <u>PCM</u>: Dolby Digital Plus or Dolby TrueHD PCM sound is output in 2 channels.
DTS   Not making the proper settings may result in noise, or some trouble for digital recording.	<ul style="list-style-type: none"> ● <u>Bitstream</u>: When connecting to equipment displaying the DTS logo. ● <u>PCM</u>: When connecting to equipment not displaying the DTS logo. 	
DTS-HD  High Resolution Audio	<ul style="list-style-type: none"> ● <u>Bitstream</u>: The bitstream signal of DTS Digital Surround is output. ● <u>PCM</u>: DTS-HD PCM sound is output in 2 channels. 	
BD-Video Function Sound <u>BD-V</u> This will set the operation sounds you hear from the menu, etc. while playing a BD-Video disc. Please note that if you have selected "Bitstream" digital audio output (➡ above), these sounds will not be heard even if this is set to "On".	<ul style="list-style-type: none"> ● <u>On</u> ● <u>Off</u> 	
<ul style="list-style-type: none"> ● <u>Note</u>: When "On" is selected, sampling frequency is converted to 48kHz. Sound is output at higher than 48kHz sampling frequency only when both this item and "PCM Down Conversion" are set to "Off". 		
Display	Status Messages Choose whether to show status messages automatically.	<ul style="list-style-type: none"> ● <u>Automatic</u> ● <u>Off</u>
	On-screen Language Choose the language for these menus and on-screen messages.	<ul style="list-style-type: none"> ● <u>English</u> ● <u>Español</u> ● <u>Français</u>
	FL Display Changes the brightness of the unit's display.	<ul style="list-style-type: none"> ● <u>Bright</u> ● <u>Dim</u>: The display is dimmed and the illumination lamp is turned off. ● <u>Automatic</u>: The display is dimmed and the illumination lamp is turned off during playback, and reappears if a button is pressed.
License	Information Information about the software used by this unit is displayed.	
	Connection	TV Aspect Set to match the type of television connected.
Component Video Resolution This sets the video output resolution when using the component video terminal.		<ul style="list-style-type: none"> ● <u>480i</u> ● <u>480p</u> ● <u>720p</u> ● <u>1080i</u>

Tabs	Menus	Options (Underlined items are the factory presets.)
Connection (Continued)	Speaker You can set the unit to output the best possible sound for your speakers. Select "2 Channel" if the speaker settings can be set on the connected equipment.	<ul style="list-style-type: none"> ● <u>Multi-channel</u>: When using three or more speakers with equipment that cannot set the speaker settings. You can adjust the settings for speaker size, presence, channel balance and audio-delay (► below). ● 2 Channel: When using two speakers. ● <u>Attenuator</u>: When audio is output from 2ch or 7.1ch AUDIO OUT terminals and sound is distorted. <ul style="list-style-type: none"> ● On ● <u>Off</u>
	HDMI	<ul style="list-style-type: none"> ● <u>On</u>: Note: Video from COMPONENT VIDEO OUT terminal is output as "480i" if this is selected. ● Off ● <u>Auto</u>: Automatically selects the output resolution best suited to the connected television (1080p, 1080i, 720p or 480p). <ul style="list-style-type: none"> ● 480p ● 720p ● 1080i ● 1080p ● <u>Standard</u>: When the black and white images are not distinct. ● <u>Enhanced</u>: When the black and white images are not distinct. ● <u>On</u>: When the TV is connected to this unit with an HDMI cable, and you are connected to an amplifier/receiver that does not support HDMI. ● <u>Off</u>: When the TV is connected to this unit with an HDMI cable, and you are connected to an amplifier/receiver that does not support HDMI. ● <u>On</u>: Set to use "HDAVI Control" function when connected with an HDMI cable to a device that supports "HDAVI Control". ● <u>Off</u>: Select when you do not want to use "HDAVI Control".
	HDMI Video Mode Select "On" when video is output from HDMI AV OUT terminal.	
	HDMI Resolution You can only select settings compatible with the connected equipment. This setting normally does not need to be changed. However if you are concerned about output picture quality, it may be improved by changing the setting. Still pictures play at a resolution equivalent to 480p regardless of the settings.	
	HDMI RGB Output Range Effective when connected to a device that only supports RGB output.	
	HDMI Audio Output This setting selects whether or not to output audio from HDMI. Note : If "On" is selected, audio output from the 7.1ch AUDIO OUT terminal will match the number of channels on the equipment connected with HDMI.	
	Ctrl with HDMI Set to use "HDAVI Control" function when connected with an HDMI cable to a device that supports "HDAVI Control".	

Changing the speaker setting to suit your speakers

When connecting to an amplifier/receiver to enjoy multi-channel surround sound, use the following settings on this unit if they cannot be set on the amplifier/receiver.

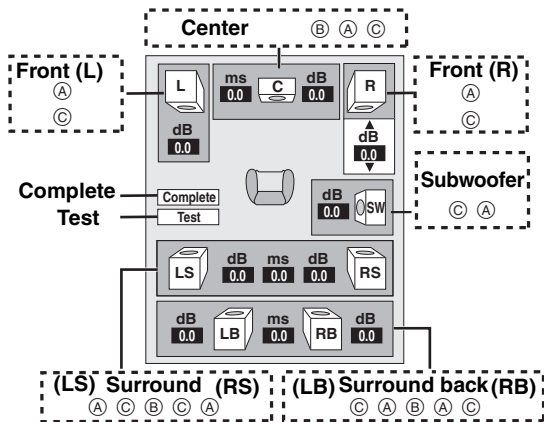

Speaker presence and size (A)

1 Press [▲, ▼, ◀, ▶] to select the speaker icon (A) and press [ENTER].

2 Press [▲, ▼] to select the setting and press [ENTER].

Icon examples:

Surround speaker (LS)

● **Large**: Select when the speaker supports low-frequency (under 100 Hz) reproduction.



● **Small**: Select when the speaker does not support low-frequency reproduction.

When playing discs recorded with Dolby TrueHD or DTS-HD, even if you select "Small", audio output will have an effect similar to when "Large" is selected.

In order to make an ideal listening environment, settings of speaker sizes may be automatically adjusted.

For example, if the subwoofer is set to "No", the front speakers will automatically be set to "Large". (In this case, we recommend connecting a speaker that can reproduce bass below 100 Hz.)

Delay time (B)

(Effective when playing multi-channel audio)

(Center, surround and surround back speakers only)

For optimum listening with 7.1/5.1-channel sound, all the speakers, except for the subwoofer, should be the same distance from the seating position.

If you have to place the center, surround and surround back speakers closer to the seating position, adjust the delay time to make up for the difference.

If either distance (D) or (E) is less than (E), find the difference in the relevant table and change to the recommended setting.

1 Press [▲, ▼, ◀, ▶] to select the delay time box (B) and press [ENTER].

2 Press [▲, ▼] to select the setting and press [ENTER].

5.1ch speaker connection

7.1ch speaker connection

Approximate room dimensions

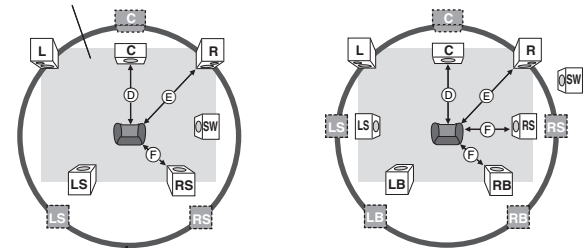

Circle of constant primary listening distance

□: Actual speaker position (D) (E) (F): Primary listening distance

■: Ideal speaker position

(D) Center speaker

Difference	Setting
Approx. 34 cm (1¼ ft.)	1.0 ms
Approx. 68 cm (2½ ft.)	2.0 ms
Approx. 102 cm (3¾ ft.)	3.0 ms
Approx. 136 cm (4¾ ft.)	4.0 ms
Approx. 170 cm (5½ ft.)	5.0 ms

(F) Surround/Surround back speakers

Difference	Setting
Approx. 170 cm (5½ ft.)	5.0 ms
Approx. 340 cm (11 ft.)	10.0 ms
Approx. 510 cm (16½ ft.)	15.0 ms

Channel balance (C)

(Effective when playing multi-channel audio)

This does not work when connected with HDMI terminals and "HDMI Audio Output" (► above, "HDMI" tab) is set to "On".

1 Select "Test" and press [ENTER].

A test signal is output.

Front (L) → Center → Front (R) → Surround (RS)

↑ ↓
Surround (LS) ← Surround Back (LB) ← Surround Back (RB)

2 While listening to the test signal, press [▲ ▼] to adjust the volume of each speaker

Front speakers: 0.0 to -6.0 dB

Except for front speakers: 0.0 to -12.0 dB

3 Press [ENTER].

The test signal stops.

● No signal is output for the subwoofer. To adjust its volume, play something, then return to this screen to adjust to suit your taste.

To finish the speaker setting

Press [▲ ▼ ◀ ▶] to select "Complete" and press [ENTER].

Frequently asked questions

Refer to the following items if you have any doubts about unit operations.

Setup

		Page
What do I need to play multi channel surround sound?	<ul style="list-style-type: none"> •Connect to... <ul style="list-style-type: none"> –an amplifier/receiver compatible with HDMI. –an amplifier/receiver with 7.1ch/5.1ch AUDIO IN. –an amplifier/receiver with a built-in (Dolby Digital or DTS) decoder. 	9, 10
Are headphones and speakers directly connected to the unit?	<ul style="list-style-type: none"> •You cannot directly connect them to the unit. Connect through the amplifier/receiver, etc. 	9, 10
Is my television progressive output compatible?	<ul style="list-style-type: none"> •All Panasonic televisions that have 480p input terminals are compatible. Consult the manufacturer if you have another brand of television. 	—
My television has S VIDEO IN terminal, COMPONENT VIDEO IN terminals and HDMI IN terminal. Which should I connect with?	<ul style="list-style-type: none"> •The different levels of picture quality input are listed below in order from highest to lowest. HDMI IN→COMPONENT VIDEO IN→S VIDEO IN→VIDEO IN. However, it will take longer for the picture output to start up when this unit is connected with the HDMI IN terminal. 	—

Disc

Can I play BD-Video, DVD-Video, DVD-Audio and Video CDs bought in another country?	<ul style="list-style-type: none"> •You can play them if the video standard is NTSC, however, you cannot play: <ul style="list-style-type: none"> –BD-Video discs that do not include region "A". –DVD-Video discs that do not include region "1" or "ALL". Refer to the disc's jacket for more information. 	Cover Cover
Can BD-Video/DVD-Video that does not have a region code/number be played?	<ul style="list-style-type: none"> •The region management information for BD-Video/DVD-Video indicates that the disc conforms to industry standards. You cannot play discs that do not conform to industry standards or do not have a region code or number. 	—
Please tell me about disc compatibility with this unit.	<ul style="list-style-type: none"> •This unit plays BD-Video, DVD-Video, DVD-Audio, Video CD, CD, DVD-RAM (DVD Video Recording format/AVCHD format/JPEG), DVD-R/RW (DVD-Video format, DVD Video Recording format and AVCHD format), DVD-R DL (DVD-Video format, DVD Video Recording format and AVCHD format), +R, +RW and +R DL. •This unit also plays CD-R/CD-RW discs which have been recorded in one of the following standards: CD-DA, Video CD, MP3 and still pictures (JPEG). Close the session after recording. •You cannot write to a disc with this unit. 	4 4 —

Troubleshooting guide

Before requesting service, make the following checks. If you are in doubt about some of the check points, or if the solutions indicated in the chart do not solve the problem, refer to "Customer Services Directory" on page 30 if you reside in the U.S.A., or refer to "Product information" on page 28 if you reside in Canada.

The following do not indicate a problem with this unit:

- Regular disc rotating sounds.
- Image disturbance during search.

To reset this unit

		Page
To return to the factory preset (No setting)	<ul style="list-style-type: none"> •Reset the unit as follows: <ol style="list-style-type: none"> 1 Press [⏻/I POWER] on the unit to turn off the unit. 2 Press and hold [▶▶/▶▶], [▲ OPEN/CLOSE] and [■] on the unit at the same time until "HELLO" appears on the display. 3 Wait until "TEST" appears next. 4 Press [⏻/I POWER] on the unit to turn off the unit. 5 Disconnect the AC power supply cord.Wait one minute, then reconnect it. 	—
To return all settings other than the ratings level to the factory preset	<ul style="list-style-type: none"> •Select "Yes" in "Restore Default Settings" in the Setup menu. This returns all values in the Setup menus and On-screen menu, except for the ratings level, to the default settings. 	21
To restore the unit if it freezes due to one of the safety devices being activated	<ul style="list-style-type: none"> •Press and hold [⏻/I POWER] on the main unit for 10 seconds. (The settings remain unchanged.) 	—

Power

No power.	<ul style="list-style-type: none"> •Insert the AC power supply cord securely into a known active AC outlet. 	8, 9
The unit switches to standby mode.	<ul style="list-style-type: none"> •This is a power saving feature. It can be changed if desired using "Off Timer" in the Setup menu. •One of the unit's safety devices is activated. Press [⏻/I POWER] on the main unit to turn the unit on. 	21 —

Operation		Page
Cannot operate the television.	<ul style="list-style-type: none"> Change the manufacturer code. Some televisions cannot be operated even if you change the code. It may be necessary to set the manufacturer code again after changing the batteries. 	11
The remote control doesn't work properly.	<ul style="list-style-type: none"> The remote control and main unit are using different codes. Change the code on the remote control. Press and hold [ENTER] and the indicated number button at the same time for more than 2 seconds.  <ul style="list-style-type: none"> The batteries are depleted. Replace them with new ones. You are not pointing the remote control at the main unit's remote control signal sensor during operation. Colored glass may obstruct the signal reception/transmission. Don't place the signal sensor in direct sunlight or in areas that may be subject to sunlight exposure. It may be necessary to set the code on the remote control again after changing the batteries. 	11 7 7 — — 11
The unit is on but cannot be operated.	<ul style="list-style-type: none"> Some operations may be prohibited by the disc. The unit is hot ("U59" appears on the display). Wait for "U59" to disappear. One of the unit's safety devices may have been activated. Reset the unit as follows: <ol style="list-style-type: none"> Press [⏻/I POWER] on the main unit to switch the unit to standby. If the unit doesn't switch to standby, press and hold [⏻/I POWER] on the main unit for about 10 seconds. The unit is forcibly switched to standby. Alternatively, disconnect the AC power supply cord, wait one minute, then reconnect it. Press [⏻/I POWER] on the main unit to switch it on. If the unit still cannot be operated, consult the dealer. Condensation has formed: Wait 1 to 2 hours for it to evaporate. 	— — — —
Play fails to start even when [▶] (PLAY) is pressed. Play starts but then stops immediately.	<ul style="list-style-type: none"> Insert the disc correctly with the label facing up. The disc is dirty. You tried to play a blank disc or unplayable disc on this unit. 	12 27 4, 5
Cannot eject disc.	<ul style="list-style-type: none"> The unit may have a problem. While the unit is off, press and hold [■] and [▶▶/▶▶▶] on the main unit at the same time for about 5 seconds. Remove the disc and consult the dealer. 	—
Startup is slow.	<ul style="list-style-type: none"> Startup takes time in the following situations. <ul style="list-style-type: none"> Immediately after a power failure or the AC power supply cord is connected. When the unit is connected with an HDMI cable. 	—
When the unit is turned on, audio and video output takes a long time.		

Displays

The display is dim.	<ul style="list-style-type: none"> Change "FL Display" in the Setup menu. 	22
The elapsed time displayed is actually less than the playtime.	<ul style="list-style-type: none"> The displayed play time is converted from the number of frames at 29.97 frames (equal to 0.999 seconds) to one second. There will be a slight difference between the time displayed and the actual elapsed time (e.g., actual one-hour elapsed time may display as approximately 59 minutes 56 seconds). 	—

TV screen and video

The images from this unit do not appear on the television.	<ul style="list-style-type: none"> Make sure that the television is connected to the VIDEO OUT terminal, S VIDEO OUT terminal, COMPONENT VIDEO OUT terminals or HDMI AV OUT terminal on this unit. Make sure that the television's input setting (e.g., VIDEO 1) is correct. Progressive output is set to on but the connected television is not progressive compatible. While stopped, press and hold [■] and [▶] (PLAY) on the main unit at the same time for more than 5 seconds to cancel this setting. The setting will change to interlace. 	8, 9 — —
Picture is distorted.		
Video is not output in high definition.	<ul style="list-style-type: none"> High definition video cannot be output through the VIDEO OUT or S VIDEO OUT terminals. Depending on the BD-Video, output from the COMPONENT VIDEO OUT terminals may be restricted to 480p. 	— —
Status messages do not appear.	<ul style="list-style-type: none"> Select "Automatic" in "Status Messages" in the Setup menu. 	22
The 4:3 aspect ratio picture expands left and right.	<ul style="list-style-type: none"> Use the television to change the aspect. Refer to your television's operating instructions. If connecting with a component video cable, set "Progressive" to "Off" in the Video menu. If this doesn't help or you cannot set it to "Off", then set the "TV Aspect" to "4:3 Pan & Scan" in the Setup menu. 	— 20, 22
Screen size is wrong.		
There is a lot of after-image when playing video.	<ul style="list-style-type: none"> Turn "3D-NR", "Integrated DNR" or "DNR" off if it is on. 	14, 20
When playing DVD-Video using progressive output, one part of the picture momentarily appears to be doubled up.	<ul style="list-style-type: none"> Set "Progressive" in the Video menu to "Off". This problem is caused by the editing method or material used on DVD-Video, but should be corrected if you use interlace output. 	20
There is no apparent change in picture quality when adjusted with the Video menu in the On-screen menu.	<ul style="list-style-type: none"> The effect is less perceivable with some types of video. 	—

Sound		Page	
No sound. Low volume. Distorted sound. Cannot hear the desired audio type.	<ul style="list-style-type: none"> ● Check the connections and the "Digital Audio Output" settings. Check the input mode on the amplifier/receiver if you have connected one. ● Press [AUDIO] to select the audio. ● Turn off V. Surround Sound in the following cases. <ul style="list-style-type: none"> – When using discs that do not have surround sound effects such as Karaoke discs. – When playing bilingual broadcast programs. ● BD-V When playing discs recorded with Dolby TrueHD or DTS-HD, audio will not be output properly unless the number of connected speakers is the same as the disc's channel specification. ● DVD-A The disc may have restrictions on the method of audio output. With some multi-channel discs, unless the number of connected speakers is the same as the disc's channel specification, audio will not be output properly. Refer to the disc's jacket for more information. ● Set "Attenuator" in "Connection" tab to "On" if it causes distortion with AUDIO OUT connections. ● Match the speaker settings with the connected equipment. Change multi channel speaker settings by selecting "Multi-channel" in "Speaker" of "Connection" tab. ● The sound effects will not work when the bitstream signal is output from the HDMI AV OUT terminal or the DIGITAL AUDIO OUT terminal. ● If the audio track of the disc was recorded with Dolby Digital Plus or Dolby True HD, Dolby Digital audio will be output from the DIGITAL AUDIO OUT terminal. ● If the audio track of the disc was recorded with DTS-HD Master Audio, it will be output as DTS Digital Surround audio. 	<p>8–10, 22</p> <p>13</p> <p>20</p> <p>—</p> <p>—</p> <p>23</p> <p>23</p> <p>—</p> <p>—</p> <p>—</p>	
	Cannot switch audio.	<ul style="list-style-type: none"> ● There are discs for which audio cannot be changed because of how the disc was created. ● When connecting an amplifier/receiver using a coaxial cable, optical digital audio cable or an HDMI cable, you cannot switch the audio if "Dolby Digital" is set to "Bitstream". Set "Dolby Digital" to "PCM" or connect using audio cables. 	<p>—</p> <p>9, 10, 22</p>

HDMI connections

The images from this unit do not appear on the television.	<ul style="list-style-type: none"> ● To output video from a device connected with an HDMI cable, set "HDMI Video Mode" to "On" in the Setup menu. 	23
Picture is distorted.	<ul style="list-style-type: none"> ● Picture may not be seen when more than 4 devices are connected with HDMI cables. Reduce the number of connected devices. 	—
The 4:3 aspect ratio picture expands left and right.	<ul style="list-style-type: none"> ● Change "TV Aspect" type to "16:9". 	22
Screen size is wrong.		
When playing DVD-Video using progressive output, one part of the picture momentarily appears to be doubled up.	<ul style="list-style-type: none"> ● When you use the HDMI AV OUT terminal for video output, follow the steps below for setting. <ol style="list-style-type: none"> 1 Connect this unit to the TV with any cable except the HDMI cable 2 Set "HDMI Video Mode" to "Off" in the Setup menu 	23
No sound. Low volume. Distorted sound. Cannot hear the desired audio type.	<ul style="list-style-type: none"> ● DVD-A The disc may have a restriction on the method of audio output. This unit cannot playback multi-channel discs that prevent down-mixing unless the unit is connected with an HDMI cable to an amplifier/receiver supporting the HDCP. Refer to the disc jacket for more information. 	—
	<ul style="list-style-type: none"> ● Audio may not be heard when more than 4 devices are connected with HDMI cables. Reduce the number of connected devices. 	—
	<ul style="list-style-type: none"> ● The sound effects will not work when the bitstream signal is output from the HDMI AV OUT terminal or the DIGITAL AUDIO OUT terminal. 	—
	<ul style="list-style-type: none"> ● To output audio from a device connected with an HDMI cable, set "HDMI Audio Output" to "On" in the Setup menu. 	23
	<ul style="list-style-type: none"> ● If the unit is connected to a television with an HDMI cable and the audio from the 7.1ch AUDIO OUT terminal is output as two channels only, set "HDMI Audio Output" to "Off" in the Setup menu. 	23
	<ul style="list-style-type: none"> ● If the sound is distorted when the unit is connected to an amplifier/receiver with the HDMI cable, adjust the settings in "Speaker" in the Setup menu to match the connection. 	23
	<ul style="list-style-type: none"> ● Depending on the connected equipment, the sound may be distorted if this unit is connected with an HDMI cable. 	—
	<ul style="list-style-type: none"> ● The sound effects will not work when the bitstream signal is output from the HDMI AV OUT terminal. 	—
Cannot switch audio.	<ul style="list-style-type: none"> ● When connecting an amplifier/receiver using a coaxial cable, optical digital audio cable or an HDMI cable, you cannot switch the audio if "Dolby Digital" is set to "Bitstream". Set "Dolby Digital" to "PCM" or connect using audio cables. 	9, 10, 22

Other difficulties with playback

Audio and video momentarily pause.	<ul style="list-style-type: none"> ● This occurs between playlist chapters. 	—
DVD-Video is not played.	<ul style="list-style-type: none"> ● You have set a ratings level to limit DVD-Video play. Change this setting. 	21
BD-Video is not played.	<ul style="list-style-type: none"> ● You have set a ratings level to limit BD-Video play. Change this setting. ● Some BD-Video can only be output with HDMI. 	21
Alternative soundtrack and subtitles cannot be selected.	<ul style="list-style-type: none"> ● The languages are not recorded on the disc. 	—
	<ul style="list-style-type: none"> ● You may not be able to use the On-screen menu to change the soundtrack and subtitles on some discs. Use the disc's menus to make changes. 	15
No subtitles.	<ul style="list-style-type: none"> ● Subtitles are not recorded on the disc. 	—
	<ul style="list-style-type: none"> ● Turn the subtitles on. Set "Subtitle" on the On-screen menu to "On". 	19
	<ul style="list-style-type: none"> ● When progressive output is on, closed captions cannot be displayed. 	—
The subtitles overlap closed captions recorded on discs.	<ul style="list-style-type: none"> ● Clear the subtitles. 	19
Angle cannot be changed.	<ul style="list-style-type: none"> ● Angles can only be changed during scenes where different angles are recorded. 	—
The resume play function does not work.	<ul style="list-style-type: none"> ● Memorized positions are canceled when <ul style="list-style-type: none"> – press [■] several times. – open the disc tray. – DVD-A CD VCD MP3: turn off the power. 	—

Messages

The following messages or service numbers appear on the television or unit's display when something unusual is detected during startup and use.

On the television

		Page
Cannot play.	●You inserted an incompatible disc (Discs recorded in PAL video, etc.).	4, 5
Cannot display on this unit.	●You tried to play a non-compatible image.	5
Copyrighted material. Audio will not be output from HDMI.	●Should you connect equipment that does not support HDCP, the audio from the CPPM copy protected DVD-Audio cannot be output from HDMI AV OUT terminal. Connect the audio cable of the Audio/Video cable (Red, White), optical digital audio cable or coaxial cable to the corresponding terminals.	8–10
No disc	●The disc may be upside down.	—
⊘	●The operation is prohibited by the unit or disc.	—

On the unit's display

F99	●The unit fails to operate properly. Press [⏻/I POWER] on the main unit to switch the unit to standby. Now press [⏻/I POWER] on the main unit again to turn the unit on.	—
HDMI ONLY*	●Some BD-Video discs can only be output with HDMI.	—
No PLAY	●When there is a viewing restriction on a BD-Video or DVD-Video.	21
No READ	●The disc is dirty or badly scratched. The unit cannot play.	—
PLEASE WAIT*	●Displayed when the unit is started and turned off. This is not a malfunction. ●The unit is carrying out its recovery process. You cannot operate the unit while "PLEASE WAIT" is displayed.	— —
SET □ (“□” stands for a number.)	●The remote control and main unit are using different codes. Change the code on the remote control.  Press and hold [ENTER] and the indicated number button at the same time for more than 2 seconds.	11
UNFORMAT*	●You inserted an unformatted DVD-RAM, DVD-RW, +RW, an unused +R, +R DL or DVD-RW (DVD-Video format).	—
UNSUPPORT*	●You have inserted a disc the unit cannot play.	4, 5
U59	●The unit is hot. The unit switches to standby for safety reasons. Wait for about 30 minutes until the message disappears. Select a position with good ventilation when installing the unit. Do not block the cooling fan on the rear of the unit.	—
U72 U73	●The HDMI connection acts unusually. –The connected equipment is not HDMI compatible. –Please use HDMI cables that have the HDMI logo (as shown on the cover). –The HDMI cable is damaged.	—
H□□ or F□□	●There is something unusual. (The service number displayed after H and F depends on the unit's condition.) ●Check the unit using the troubleshooting guide. If the service number does not disappear, do the following. 1. Disconnect the plug from the AC outlet, wait a few seconds, then reconnect it. 2. Press [⏻/I POWER] to turn the power on. (The unit may be fixed.) If the service number does not disappear despite doing the above, request service from the dealer. Inform the dealer of the service number when requesting service.	— 24–26

* The messages are alternately displayed.

Disc handling

Clean discs

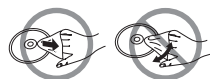

Wipe with a damp cloth and then wipe dry.

Disc handling precautions

- Do not attach labels or stickers to discs (This may cause disc warping, rendering it unusable).
- Do not write on the label side with a ball-point pen or other writing instrument.
- Do not use record cleaning sprays, benzene, thinner, static electricity prevention liquids or any other solvent.
- Do not use scratch-proof protectors or covers.
- Do not use the following discs:
 - Discs with exposed adhesive from removed stickers or labels (rented discs etc).
 - Discs that are badly warped or cracked.
 - Irregularly shaped discs, such as heart shapes.

Maintenance

Clean this unit with a soft, dry cloth

- Never use alcohol, paint thinner or benzene to clean this unit.
- Before using chemically treated cloth, read the instructions that came with the cloth carefully.
- Cleaning of the lens is generally not necessary.
- Do not use any lens cleaners as they may damage the unit.

Product Service

- Damage requiring service**—The unit should be serviced by qualified service personnel if:
 - The AC power supply cord or AC adaptor has been damaged; or
 - Objects or liquids have gotten into the unit; or
 - The unit has been exposed to rain; or
 - The unit does not operate normally or exhibits a marked change in performance; or
 - The unit has been dropped or the cabinet damaged.
- Servicing**—Do not attempt to service the unit beyond that described in these operating instructions. Refer all other servicing to authorized servicing personnel.

- Replacement parts**—When parts need replacing ensure the servicer uses parts specified by the manufacturer or parts that have the same characteristics as the original parts. Unauthorized substitutes may result in fire, electric shock, or other hazards.
- Safety check**—After repairs or service, ask the servicer to perform safety checks to confirm that the unit is in proper working condition.

Product information

For product information or assistance with product operation:

In the U.S.A., refer to "Customer Services Directory" on page 30. In Canada, contact the Panasonic Canada Inc. Customer Care Centre at 1-800-561-5505, or visit the website (www.panasonic.ca), or an authorized Servicentre closest to you.

Specifications

Signal system: NTSC
Operating temperature range: +5 to +35 °C (+41 to +95 °F)
Operating humidity range: 10 to 80 % RH (no condensation)

Discs played [8 cm (3 ") or 12 cm (5 ")]:
 BD (BD-Video)
 DVD (DVD-Video, DVD-Audio)
 DVD-RAM (DVD-VR, JPEG*1, 2, 6, AVCHD)
 DVD-R/RW/-R DL (DVD-Video, DVD-VR, AVCHD)
 +R/+RW/+R DL (Video)
 CD, CD-R/RW
 (CD-DA, Video CD, SVCD*4, MP3*3, 5, JPEG*1, 3, 6)

Video output:
 Output level: 1 Vp-p (75 Ω)
 Output connector: Pin jack (1 system)

S-video output:
 Y output level: 1 Vp-p (75 Ω)
 C output level: 0.286 Vp-p (75 Ω) at Burst
 Output connector: S terminal (1 system)

Component video output: (1080i/720p/480p/480i)
 Y output level: 1 Vp-p (75 Ω)
 P_B output level: 0.7 Vp-p (75 Ω)
 P_R output level: 0.7 Vp-p (75 Ω)
 Output connector: Pin jack (Y: green, P_B: blue, P_R: red) (1 system)

Audio output:
 Output level: 2 Vrms (1 kHz, 0 dB)
 Output connector: Pin jack
 Number of connectors: 2 channel: 2 system
 7.1 channel discrete output (7.1 channel): 1 system

Audio performance:
 Frequency response:
 • DVD (linear audio): 2 Hz to 22 kHz (48 kHz sampling)
 2 Hz to 44 kHz (96 kHz sampling)
 • DVD-Audio: 2 Hz to 88 kHz (192 kHz sampling)
 • CD-Audio: 2 Hz to 20 kHz
 S/N ratio: 125 dB
 Dynamic range: 118 dB
 Total harmonic distortion: 0.0012 %

Digital audio output:
 Optical digital output: Optical terminal
 Coaxial digital output: Pin jack

HDMI AV output
 Output format:
 • Video: 1080p/1080i/720p/480p
 • Audio: 192 kHz/96 kHz/48 kHz/44.1 kHz
 Output Connector: Type A (19 pin)
 • This unit supports "HDMI Control 2" function.

Optical pick-up: System with 2 lenses

LASER Specification:
 Wave length: 785 nm (CDs)/662 nm (DVDs)/405 nm (BDs)
 Laser power:
 No hazardous radiation is emitted with the safety protection

Power supply: AC 120 V, 60 Hz
Power consumption: approx. 42 W

Power consumption in standby mode: less than 1 W

Dimensions (W×D×H)
Excluding the projecting parts: 430 mm×331.6 mm×85 mm
 (16 15/16"×13 1/16"×3 3/8")
Including the projecting parts: 430 mm×338.3 mm×85 mm
 (16 15/16"×13 3/8"×3 3/8")
Mass (Weight): approx. 4.5 kg (9.9 lbs)

Note

Specifications are subject to change without notice.

- *1 Picture resolution: between 34×34 and 6144×4096 pixels (sub sampling is 4:2:2 or 4:2:0)
- *2 The total combined maximum number of recognizable picture contents and folders: 3000 picture contents and 300 folders.
- *3 The total combined maximum number of recognizable audio and picture contents and folders: 999 audio and picture contents and 99 folders.
- *4 Conforming to IEC62107
- *5 Compatible compression rate: between 32 kbps and 320 kbps
 Compatible sampling rate: 44.1 kHz, 48 kHz
- *6 MOTION JPEG is not supported.

Language code list Enter the code with the numbered buttons.

Abkhazian: 6566	Catalan: 6765	Gujarati: 7185	Lingala: 7678	Rhaeto-Romance: 8277	Tamil: 8465
Afar: 6565	Chinese: 9072	Hausa: 7265	Lithuanian: 7684	Romanian: 8279	Tatar: 8484
Afrikaans: 6570	Corsican: 6779	Hebrew: 7387	Macedonian: 7775	Russian: 8285	Telugu: 8469
Albanian: 8381	Croatian: 7282	Hindi: 7273	Malagasy: 7771	Samoan: 8377	Thai: 8472
Ameharic: 6577	Czech: 6783	Hungarian: 7285	Malay: 7783	Sanskrit: 8365	Tibetan: 6679
Arabic: 6582	Danish: 6865	Icelandic: 7383	Malayalam: 7776	Scots Gaelic: 7168	Tigrinya: 8473
Armenian: 7289	Dutch: 7876	Indonesian: 7378	Maltese: 7784	Serbian: 8382	Tonga: 8479
Assamese: 6583	English: 6978	Interlingua: 7365	Maori: 7773	Serbo-Croatian: 8372	Turkish: 8482
Aymara: 6589	Esperanto: 6979	Irish: 7165	Marathi: 7782	Shona: 8378	Turkmen: 8475
Azerbaijani: 6590	Estonian: 6984	Italian: 7384	Moldavian: 7779	Sindhi: 8368	Twi: 8487
Bashkir: 6665	Faroese: 7079	Japanese: 7465	Mongolian: 7778	Singhalese: 8373	Ukrainian: 8575
Basque: 6985	Fiji: 7074	Javanese: 7487	Nauru: 7865	Slovak: 8375	Urdu: 8582
Bengali; Bangla: 6678	Finnish: 7073	Kannada: 7578	Nepali: 7869	Slovenian: 8376	Uzbek: 8590
Bhutani: 6890	French: 7082	Kashmiri: 7583	Norwegian: 7879	Somali: 8379	Vietnamese: 8673
Bihari: 6672	Frisian: 7089	Kazakh: 7575	Oriya: 7982	Spanish: 6983	Volapük: 8679
Breton: 6682	Galician: 7176	Kirghiz: 7589	Pashto, Pushto: 8083	Swahili: 8387	Welsh: 6789
Bulgarian: 6671	Georgian: 7565	Korean: 7579	Persian: 7065	Sundanese: 8385	Wolof: 8779
Burmese: 7789	German: 6869	Kurdish: 7585	Polish: 8076	Swedish: 8386	Xhosa: 8872
Byelorussian: 6669	Greek: 6976	Laotian: 7679	Portuguese: 8084	Tagalog: 8476	Yiddish: 7473
Cambodian: 7577	Greenlandic: 7576	Latin: 7665	Punjabi: 8065	Tajik: 8471	Yoruba: 8979
	Guarani: 7178	Latvian, Lettish: 7686	Quechua: 8185		Zulu: 9085

Glossary

AVCHD

AVCHD is a new format (standard) for high definition video cameras that can be used to record and play high-resolution HD images.

BD-J

Some BD-Video discs contain Java applications, and these applications are called BD-J. Depending on the BD-J application, you can enjoy various interactive features in addition to playing normal video.

Bitstream

This is the digital form of multi-channel audio data (e.g., 5.1 channel) before it is decoded into its various channels.

CPPM (Content Protection for Prerecorded Media)

A copy protection system used for DVD-Audio files. This unit supports CPPM.

Decoder

A decoder restores the coded audio signals on DVDs to normal. This is called decoding.

Dolby Digital

This is a method of coding digital signals developed by Dolby Laboratories. Apart from stereo (2-channel) audio, these signals can also be multi-channel audio. A large amount of audio information can be recorded on one disc using this method.

Dolby Digital Plus

Multi-channel audio and higher audio quality is made possible using Dolby Digital Plus. Previous Dolby Digital-compatible equipment can play Dolby Digital Plus as Dolby Digital surround audio. BD-Video supports up to 7.1 channel output.

Dolby TrueHD

Dolby TrueHD is a very high quality audio format that reproduces the studio master audio. Previous Dolby Digital-compatible equipment can play Dolby TrueHD as Dolby Digital surround audio. BD-Video supports up to 7.1 channel output.

Down-mixing

This is the process of remixing the multi-channel audio found on some discs into two channels. It is useful when you want to listen to the 5.1-channel audio recorded on DVDs through your television's speakers. Some discs prohibit down-mixing and this unit can then only output the front two channels.

DVD-A Tracks that do not allow down-mixing will not play correctly on this unit except when connecting with an HDMI cable to an amplifier/receiver that meets HDMI standards (ver. 1.1 or later) and is CPPM compatible.

DTS (Digital Theater Systems)

This surround system is used in many movie theaters. There is good separation between the channels, so realistic sound effects are possible.

DTS-HD

DTS-HD is a high-quality, sophisticated audio format used in movie theaters. Previous DTS Digital Surround-compatible equipment can play DTS-HD as DTS Digital Surround audio. BD-Video supports up to 7.1 channel output.

Dynamic range

Dynamic range is the difference between the lowest level of sound that can be heard above the noise of the equipment and the highest level of sound before distortion occurs. Dynamic range compression means reducing the gap between the loudest and softest sounds. This means you can listen at low volumes but still hear dialog clearly.

Film and video

DVD-Video are recorded using either film or video. This unit can determine which type has been used, then uses the most suitable method of progressive output.

Film: Recorded at 24 frames per second. (Recorded at 30 frames per second as well). Generally appropriate for motion picture films.

Video: Recorded at 30 frames/60 fields per second. Generally appropriate for TV drama programs or animation.

Finalize

A process that makes play of a recorded CD-R, CD-RW, DVD-R, etc. possible on equipment that can play such media. After finalizing, the disc becomes play-only and you can no longer record or edit.

Frames and fields

Frames refer to the single images that constitute the video you see on your television. Each frame consists of two fields.



Frame

Field

Field

- A frame still shows two fields, so there may be some blurring, but picture quality is generally better.
- A field still shows less picture information so it may be rougher, but there is no blurring.

HDCP (High-Bandwidth Digital Content Protection)

HDCP is a type of digital rights management developed for use with HDMI connections, etc. HDCP was developed to protect digital content and prevent unsecured transmissions by using a variety of methods such as encryption and authentication.

HDMI (High-Definition Multimedia Interface)

HDMI is a digital interface for consumer electronic products. Unlike conventional connections, it transmits uncompressed digital video and audio signals on a single cable. This unit supports high-definition video output [720p (750p), 1080i (1125i), 1080p (1125p)] from HDMI AV OUT terminals. To enjoy high-definition video a high definition compatible television is required.

JPEG (Joint Photographic Experts Group)

This is a system used for compressing/decoding color still pictures. If you select JPEG as the storage system on digital cameras, etc., the data will be compressed to 1/10–1/100 of its original size. The benefit of JPEG is less deterioration in picture quality considering the degree of compression.

LPCM (Linear PCM)

These are uncompressed digital signals, similar to those found on CDs.

MP3 (MPEG Audio Layer 3)

An audio compression method that compresses audio to approximately one tenth of its size without any considerable loss of audio quality. You can play MP3 you have recorded onto CD-R and CD-RW.

Pan&Scan/Letterbox

In general, DVD-Video are produced with the intention that they be viewed on a widescreen television (16:9 aspect ratio), so images often don't fit regular (4:3 aspect ratio) televisions. Two styles of picture, "Pan & Scan" and "Letterbox", deal with this problem.

Pan&Scan: The sides are cut off so the picture fills the screen.



Letterbox: Black bands appear at the top and bottom of the picture so the picture itself appears in an aspect ratio of 16:9.



Progressive/Interlace

The video signal standard of NTSC has 480 interlaced (i) scan lines, whereas progressive (p) scanning uses twice the number of scan lines, and this is referred to as 480p. Using progressive output, you can enjoy watching high resolution video recorded on disc, such as DVD-Video. Please note that your television must be capable of progressive output to enjoy progressive video.

Sampling frequency

Sampling is the process of converting the heights of sound wave (analog signal) samples taken at set periods into digits (digital encoding). Sampling frequency is the number of samples taken per second, so larger numbers mean more faithful reproduction of the original sound.

1080i (1125i)

In one high definition image, 1080 (1125) alternating scan lines pass every 1/60th of a second to create an interlace image. Because 1080i (1125i) more than doubles current television broadcasts of 480i, the detail is much clearer and creates a more realistic and rich image.

1080p (1125p)

In one high definition image, 1080 (1125) scan lines pass at the same time every 1/60th of a second to create a progressive image. Since progressive video does not alternate scan lines like interlace, there is a minimal amount of screen flicker.

720p (750p)

In one high definition image, 720 (750) scan lines pass at the same time every 1/60th of a second to create a progressive image. Since progressive video does not alternate scan lines like interlace, there is a minimal amount of screen flicker.

Limited Warranty (ONLY FOR U.S.A.)

Panasonic Consumer Electronics Company,
Division of Panasonic Corporation of North America
One Panasonic Way Secaucus, New Jersey 07094

Panasonic Puerto Rico, Inc.
Ave. 65 de Infantería, Km. 9.5
San Gabriel Industrial Park, Carolina, Puerto Rico 00985

Panasonic BD/DVD Player Limited Warranty

Limited Warranty Coverage

If your product does not work properly because of a defect in materials or workmanship, Panasonic Consumer Electronics Company or Panasonic Puerto Rico, Inc. (collectively referred to as "the warrantor") will, for the length of the period indicated on the chart below, which starts with the date of original purchase ("Limited Warranty period"), at its option either (a) repair your product with new or refurbished parts, or (b) replace it with a new or a refurbished product. The decision to repair or replace will be made by the warrantor.

Product or Part Name	Parts	Labor
BD/DVD Player	One (1) Year	One (1) Year
Rechargeable Batteries (in exchange for defective item)	Ten (10) Days	Not Applicable

During the "Labor" Limited Warranty period there will be no charge for labor. During the "Parts" warranty period, there will be no charge for parts. You must mail-in your product during the warranty period. If non-rechargeable batteries are included, they are not warranted. This Limited Warranty only applies to products purchased and serviced in the United States or Puerto Rico. This Limited Warranty is extended only to the original purchaser and only covers product purchased as new. A purchase receipt or other proof of original purchase date is required for Limited Warranty service.

For assistance in Puerto Rico call Panasonic Puerto Rico, Inc. (787)-750-4300 or fax (787)-768-2910.

When shipping the unit carefully pack and send it prepaid, adequately insured and preferably in the original carton. Include a letter detailing the complaint and provide a day time phone and/or email address where you can be reached.

IF REPAIR IS NEEDED DURING THE LIMITED WARRANTY PERIOD THE PURCHASER WILL BE REQUIRED TO FURNISH A SALES RECEIPT/PROOF OF PURCHASE INDICATING DATE OF PURCHASE, AMOUNT PAID AND PLACE OF PURCHASE. CUSTOMER WILL BE CHARGED FOR THE REPAIR OF ANY UNIT RECEIVED WITHOUT SUCH PROOF OF PURCHASE.

Limited Warranty Limits And Exclusions

This Limited Warranty ONLY COVERS failures due to defects in materials or workmanship, and DOES NOT COVER normal wear and tear or cosmetic damage. The Limited Warranty ALSO DOES NOT COVER damages which occurred in shipment, or failures which are caused by products not supplied by the warrantor, or failures which result from accidents, misuse, abuse, neglect, mishandling, misapplication, alteration, faulty installation, set-up adjustments, misadjustment of consumer controls, improper maintenance, power line surge, lightning damage, modification, or commercial use (such as hotel, office, restaurant, or other business), rental use of the product, or service by anyone other than a Factory Servicer or other Authorized Servicer, or damage that is attributable to acts of God.

THERE ARE NO EXPRESS WARRANTIES EXCEPT AS LISTED UNDER "LIMITED WARRANTY COVERAGE". THE WARRANTOR IS NOT LIABLE FOR INCIDENTAL OR CONSEQUENTIAL DAMAGES RESULTING FROM THE USE OF THIS PRODUCT, OR ARISING OUT OF ANY BREACH OF THIS WARRANTY. (As examples, this excludes damages for lost time, cost of having someone remove or re-install an installed unit if applicable, travel to and from the servicer, loss of or damage to media or images, data or other recorded content. The items listed are not exclusive, but are for illustration only.)
ALL EXPRESS AND IMPLIED WARRANTIES, INCLUDING THE WARRANTY OF MERCHANTABILITY, ARE LIMITED TO THE PERIOD OF THE LIMITED WARRANTY.

Some states do not allow the exclusion or limitation of incidental or consequential damages, or limitations on how long an implied Limited Warranty lasts, so the exclusions may not apply to you.

This Limited Warranty gives you specific legal rights and you may also have other rights which vary from state to state. If a problem with this product develops during or after the Limited Warranty period, you may contact your dealer or Servicer. If the problem is not handled to your satisfaction, then write to the warrantor's Consumer Affairs Department at the addresses listed for the warrantor.

PARTS AND SERVICE, WHICH ARE NOT COVERED BY THIS LIMITED WARRANTY, ARE YOUR RESPONSIBILITY.

Customer Services Directory

Obtain Product Information and Operating Assistance; purchase Parts, Accessories, or obtain Literature by visiting our Web Site at:
<http://www.panasonic.com/consumersupport>
or, contact us via the web at:
<http://www.panasonic.com/contactinfo>
You may also contact us directly at:
1-800-211-PANA (7262),
Monday-Friday 9 am-9 pm; Saturday-Sunday 10 am-7 pm, EST.

For hearing or speech impaired TTY users, TTY: 1-877-833-8855

Accessory Purchases

Purchase Parts, Accessories and Instruction Books online for all Panasonic Products by visiting our Web Site at:
<http://www.pstc.panasonic.com>
or, send your request by E-mail to:
npcparts@us.panasonic.com
You may also contact us directly at:
1-800-332-5368 (Phone) 1-800-237-9080 (Fax Only) (Monday – Friday 9 am to 8 pm, EST.)
Panasonic Service and Technology Company
20421 84th Avenue South, Kent, WA 98032
(We Accept Visa, MasterCard, Discover Card, American Express, and Personal Checks)

For hearing or speech impaired TTY users, TTY : 1-866-605-1277

Product Repairs	Centralized Factory Servicer
MAIL TO:	Panasonic Service and Technology Company 410B Airport Road Elgin, IL 60123-9333 Attention: BD/DVD Repair
Please carefully pack and ship, prepaid and insured, to the Elgin Centralized Factory Servicer. Customer's in Puerto Rico, please ship or carry in to location below ("Service in Puerto Rico").	

Service in Puerto Rico

Panasonic Puerto Rico, Inc.
Ave. 65 de Infantería, Km. 9.5, San Gabriel Industrial Park, Carolina, Puerto Rico 00985
Phone (787)750-4300, Fax (787)768-2910

Limited Warranty (ONLY FOR CANADA)

Panasonic Canada Inc.

PANASONIC PRODUCT—LIMITED WARRANTY

Panasonic Canada Inc. warrants this product to be free from defects in material and workmanship and agrees to remedy any such defect for a period as stated below from the date of original purchase.

Technics Audio Product	One (1) year, parts and labour
Panasonic Portable/Clock Radio (without Tape, CD, MD)	One (1) year, parts and labour
Panasonic Audio/SD Audio Product	One (1) year, parts and labour
Panasonic BD/DVD Product	One (1) year, parts and labour
Panasonic Combination DVD Player/VCR	One (1) year, parts and labour
Panasonic Combination DVD Recorder/VCR	One (1) year, parts and labour
Accessories including rechargeable batteries	Ninety (90) days

LIMITATIONS AND EXCLUSIONS

This warranty does not apply to products purchased outside Canada or to any product which has been improperly installed, subjected to usage for which the product was not designed, misused or abused, damaged during shipping, or which has been altered or repaired in any way that affects the reliability or detracts from the performance, nor does it cover any product which is used commercially. Dry cell batteries are also excluded from coverage under this warranty.

This warranty is extended to the original end user purchaser only. A purchase receipt or other proof of date of original purchase is required before warranty service is performed.

THIS EXPRESS, LIMITED WARRANTY IS IN LIEU OF ALL OTHER WARRANTIES, EXPRESS OR IMPLIED, INCLUDING ANY IMPLIED WARRANTIES OF MERCHANTABILITY AND FITNESS FOR A PARTICULAR PURPOSE.

IN NO EVENT WILL PANASONIC CANADA INC. BE LIABLE FOR ANY SPECIAL, INDIRECT OR CONSEQUENTIAL DAMAGES.

In certain instances, some jurisdictions do not allow the exclusion or limitation of incidental or consequential damages, or the exclusion of implied warranties, so the above limitations and exclusions may not be applicable.

WARRANTY SERVICE

FOR PRODUCT OPERATION ASSISTANCE, please contact:

Our Customer Care Centre: Telephone #:	(905) 624-5505
1-800 #:	1-800-561-5505
Fax #:	(905) 238-2360
Email link:	"Customer support" on www.panasonic.ca

FOR PRODUCT REPAIRS, please locate your nearest Authorized Servicentre at www.panasonic.ca :

Link : "Servicentres™ locator" under "Customer support"

IF YOU SHIP THE PRODUCT TO A SERVICENTRE

Carefully pack and send prepaid, adequately insured and preferably in the original carton.
Include details of the defect claimed, and proof of date of original purchase.

Conexiones básicas

A Conexión a un televisor con un cable para audio/vídeo

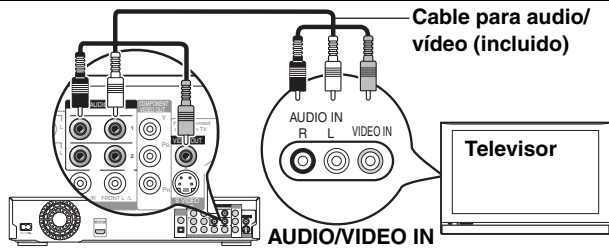

Parte posterior de la unidad

• No es posible la salida del vídeo HD (Alta definición) con esta conexión. Para el vídeo HD utilice (B) o (C).

B Conexión a un televisor con un cable HDMI

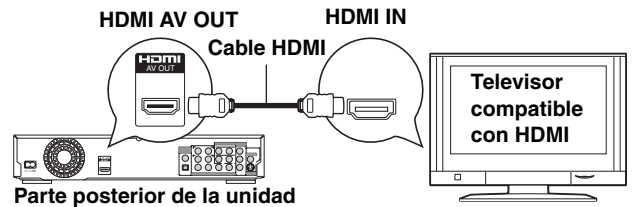

Parte posterior de la unidad

C Conexión a un amplificador/receptor y a un televisor con cables HDMI

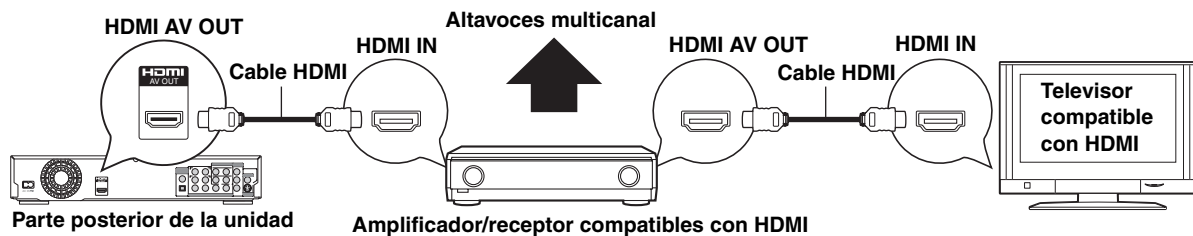

Parte posterior de la unidad

Amplificador/receptor compatibles con HDMI

Por último, conecte el cable de alimentación de CA

A una toma de red doméstica
(CA 120 V, 60 Hz)

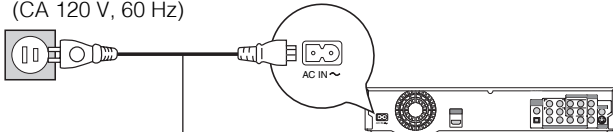

Cable de alimentación de CA (incluido)

Conéctelo sólo cuando hayan finalizado todas las demás conexiones.

Ahorro de energía

Esta unidad consume un poco de energía, incluso cuando está desconectada (menos de 1 W). Para ahorrar energía cuando la unidad no vaya a utilizarse durante un periodo prolongado de tiempo, desconéctela de la toma de red doméstica de CA.

Reproducción básica

Preparación

Encienda el televisor y seleccione la entrada de vídeo adecuada en el televisor con el mando a distancia del televisor.

- 1 Abra la cubierta frontal.
- 2 Pulse [POWER] para encender la unidad.
Cuando pulse el botón de encendido por primera vez después de haber adquirido la unidad, aparecerá una pantalla solicitándole que realice la configuración de los ajustes básicos. Siga las instrucciones en pantalla y realice la configuración.
- 3 Pulse [OPEN/CLOSE] para abrir la bandeja de discos y cargue el disco.
- 4 Pulse [PLAY] para iniciar la reproducción.

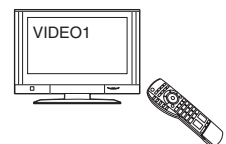

Iniciar la reproducción



Detener

Se memoriza la posición Detener.

Reanude la función de reproducción.

Pulse [PLAY] para reiniciar a partir de esta posición.

- La posición del disco se elimina si se abre la bandeja, si la unidad se apaga o si se pulsa [STOP] varias veces.
- **DVD-A CD VCD MP3**: La posición se elimina si la unidad se apaga.



Pausa

- Pulse [PAUSE] de nuevo o pulse [PLAY] para reiniciar la reproducción.



**Búsqueda/
Cámara lenta**

Búsqueda (durante la reproducción)

La velocidad aumenta hasta 5 pasos.

- Pulse [PLAY] (PLAY) para invertir a la velocidad de reproducción normal.
- **BD-V**: El audio no se oye durante todos los niveles de búsqueda.
- **DVD-V DVD-VR VCD**: Se oye el sonido durante el primer nivel de búsqueda progresiva.
- **DVD-A CD MP3**: Se oye el sonido durante todos los niveles de búsqueda.

Cámara lenta (durante la pausa)

La velocidad aumenta hasta 5 pasos.

- **BD-V VCD** Sólo en la dirección de avance [SKIP].
- Pulse [PLAY] (PLAY) para invertir a la velocidad de reproducción normal.

También puede utilizar la perilla Multi-Funcion para la opción Búsqueda/Cámara lenta.



Salto

Salte al título, capítulo o pista que quiera reproducir.

- Cada pulsación aumenta el número de saltos.

Index

- A** Age limit for BD-Video viewing 21
- Angle** 19
- Audio**
 - Attribute 19
 - Changing audio 13
 - Channel 19
 - Language 19, 21
- AVCHD** 29
- B** BD-J 29
- C** Chapter 15
- Cleaning**
 - Disc 27
 - Main unit 27
- Connection**
 - Amplifier/Receiver 9, 10
 - HDMI 8, 9
- D** Dialog Enhancer 20
- Direct Navigator** 15, 16
- Dolby Digital** 19, 22
- Dolby Digital Plus** 19, 22
- Dolby TrueHD** 19, 22
- DTS** 19, 22
- DTS-HD** 19, 22
- E** EZ Sync™ "HDAVI Control™" 18
- F** Finalize 4, 29
- H** HDCP 29
- HDMI** 8, 9, 29
- J** JPEG 5, 16, 29
- L** Language
 - Audio 19, 21
 - Code list 28
 - On-screen 22
 - Soundtrack 19, 21
 - Subtitle 19, 21
- LPCM** 19, 29
- M** Maintenance 27
- Menu**
 - On-screen 19
 - Pop-up 15
 - Setup 21
 - Sub 15, 17
- MP3** 5, 16, 29
- N** Noise reduction (NR)
 - DNR 20
 - Integrated DNR 14, 20
 - 3D-NR 14, 20
- O** Off Timer 21
- On-screen**
 - Language 22
 - Menu 19
 - Status messages 13
- P** PCM Down Conversion 22
- Picture quality adjustment** 14, 20
- Playlist** 15
- Pop-up menu** 15
- Progressive** 20, 29
- Properties**
 - Program 15
 - Still picture 17
- R** Ratings level 21
- Re-master** 14
- Remote control code** 11
- Repeat play** 20
- Restore Default Settings** 21
- Resume play function** 12
- S** Setup menu 21
- Slideshow**
 - CD-R/RW 17
 - DVD-Audio 19
 - DVD-RAM 17
- Soundtrack** 19
- Status messages** 13
- Still pictures** 16
- Subtitle** 19
- T** Time Slip 13
- Transfer** 20
- V** V. Surround Sound 20

Java and all Java-based trademarks and logos are trademarks or registered trademarks of Sun Microsystems, Inc. in the United States and other countries.

Manufactured under license from Dolby Laboratories. Dolby and the double-D symbol are trademarks of Dolby Laboratories.

"DTS" is a registered trademark of DTS, Inc. and "DTS-HD High Resolution Audio" is a trademark of DTS, Inc.

Apparatus Claims of U.S. Patent Nos. 4,631,603, 4,577,216, and 4,819,098, licensed for limited viewing uses only.

This product incorporates copyright protection technology that is protected by method claims of certain U.S. patents and other intellectual property rights owned by Macrovision Corporation and other rights owners. Use of this copyright protection technology must be authorized by Macrovision Corporation, and is intended for home and other limited viewing uses only unless otherwise authorized by Macrovision Corporation. Reverse engineering or disassembly is prohibited.

HDMI, the HDMI logo and High-Definition Multimedia Interface are trademarks or registered trademarks of HDMI Licensing LLC.

This product is licensed under the AVC patent portfolio license and VC-1 patent portfolio license for the personal and non-commercial use of a consumer to (i) encode video in compliance with the AVC Standard and VC-1 Standard ("AVC/VC-1 Video") and/or (ii) decode AVC/VC-1 Video that was encoded by a consumer engaged in a personal and non-commercial activity and/or was obtained from a video provider licensed to provide AVC/VC-1 Video. No license is granted or shall be implied for any other use. Additional information may be obtained from MPEG LA, LLC. See <http://www.mpegla.com>.

HDAVI Control™ is a trademark of Matsushita Electric Industrial Co., Ltd.

EZ Sync™ is a trademark of Matsushita Electric Industrial Co., Ltd.

"AVCHD" and the "AVCHD" logo are trademarks of Matsushita Electric Industrial Co., Ltd. and Sony Corporation.

-If you see this symbol-

Information on Disposal in other Countries outside the European Union



This symbol is only valid in the European Union. If you wish to discard this product, please contact your local authorities or dealer and ask for the correct method of disposal.



This manual was printed with soy based ink.

For U.S.A.

Panasonic Consumer Electronics Company, Division of Panasonic Corporation of North America
One Panasonic Way Secaucus,
New Jersey 07094
<http://www.panasonic.com>

Panasonic Puerto Rico, Inc.
Ave. 65 de Infantería, Km. 9.5
San Gabriel Industrial Park, Carolina,
Puerto Rico 00985

For Canada

Panasonic Canada Inc.
5770 Ambler Drive
Mississauga, Ontario
L4W 2T3
www.panasonic.ca

